

**DITHERM
LTW**

+150°C

-40°C

INOX

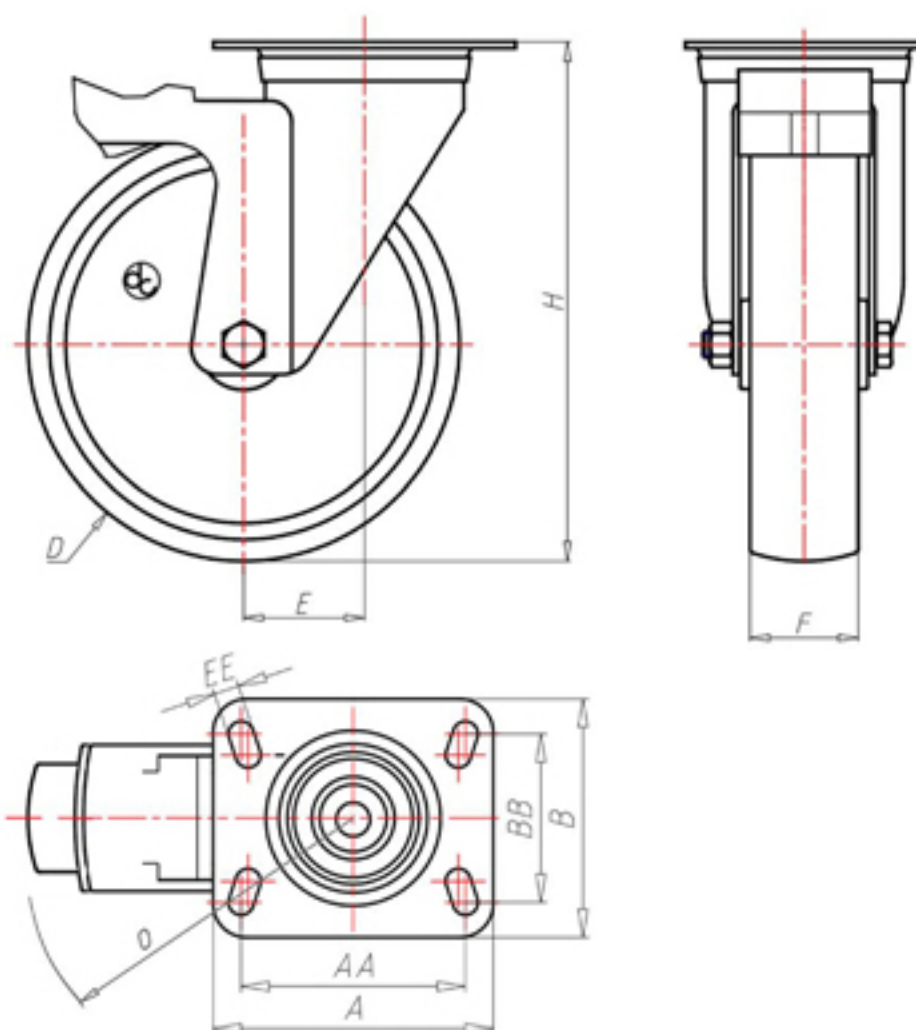

	D	100
	F	35
	H	128
	AxA	100x85
	AAxBB	80x60
	EE	9
	E	42
	O	124
	LC	220



Código para rueda con buje liso

LGX10040FS



Código para rueda con casquillo revestido en HQS

LGX10040BRFS



Código para rueda con doble casquillo autolubricante BT

LGX10040BTFS



Código para rueda con doble rodamiento de bolas HT

-

