

**DITHERM
LTW**

+150°C
-40°C

INOX

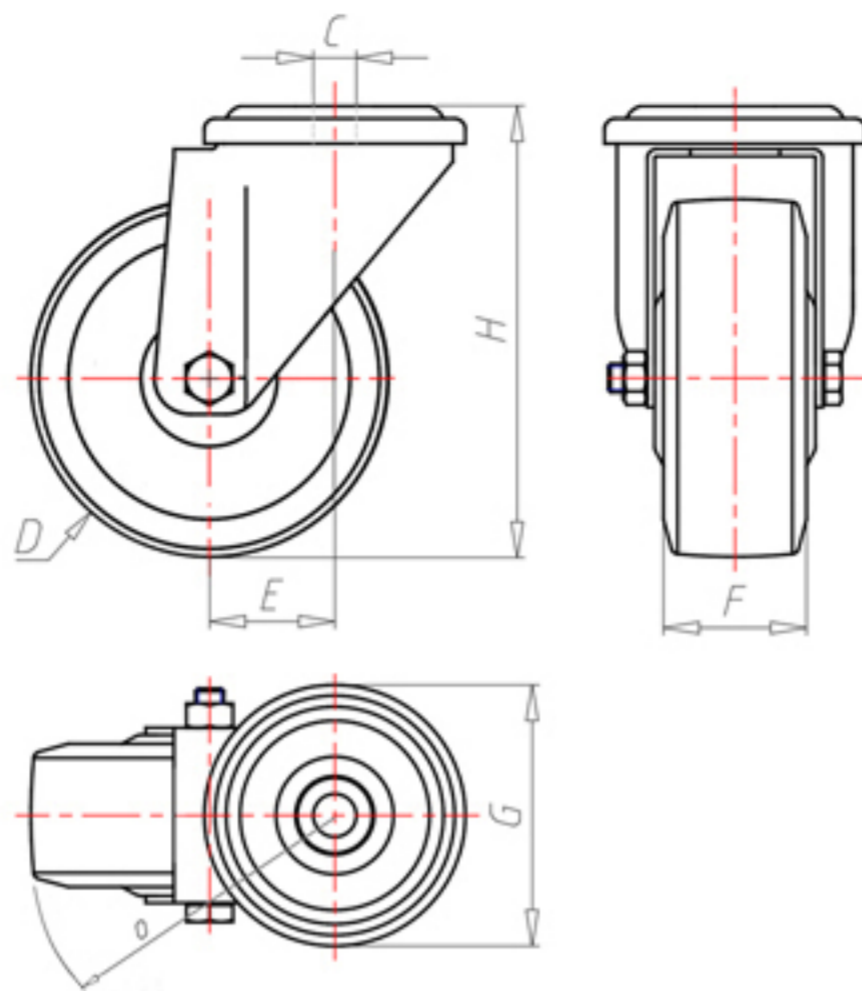

	D	200
	F	50
	H	232
	G	Ø 102
	C	Ø 16
	E	56
	O	152
	LC	400



Código para rueda con buje liso

LPX20060



Código para rueda con casquillo revestido en HQS

-



Código para rueda con doble casquillo autolubricante BT

-



Código para rueda con doble rodamiento de bolas HT

-

