

**DITHERM
STW**

+280°C
-70°C

INOX

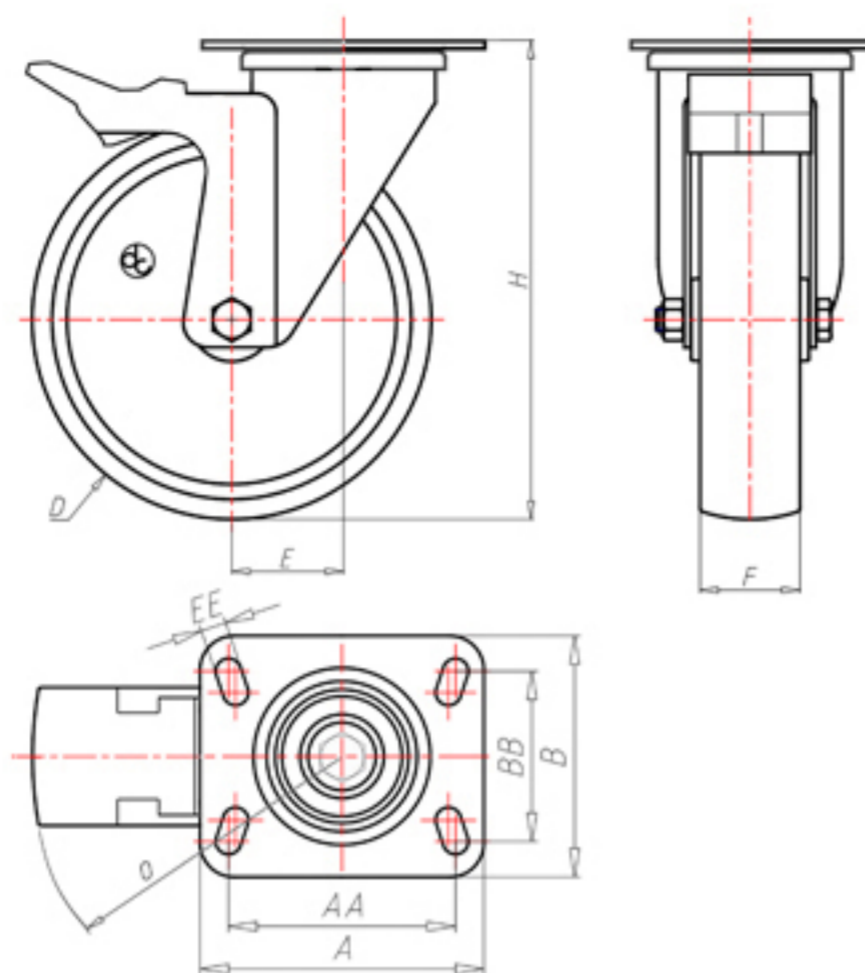

	D	80
	F	30
	H	108
	AxB	100x85
	AAxBB	80x60
	EE	9
	E	40
	O	124
	LC	200



Código para rueda con buje liso

SGX80FA



Código para rueda con casquillo revestido en HQS

SGX80BRFA



Código para rueda con doble casquillo autolubricante BT

SGX80BTFA



Código para rueda con doble rodamiento de bolas HT

SGX80CFA

