

**DITHERM
LTW**

+150°C
-40°C

INOX

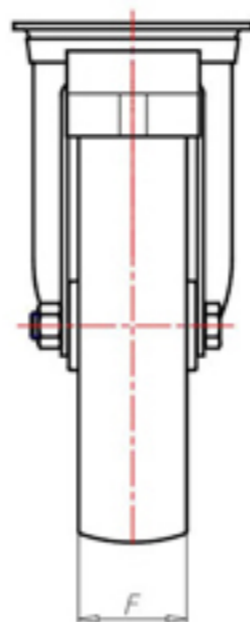
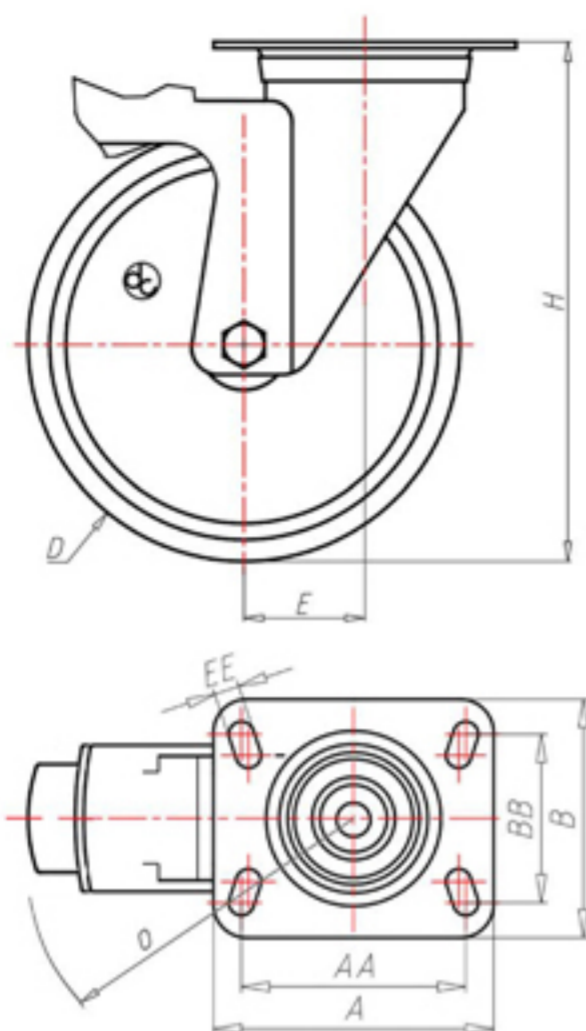

	D	150
	F	40
	H	181
	AxA	100x85
	AAxBB	80x60
	EE	9
	E	46
	O	124
	LC	250



Code pour roue à alésage lisse

LGX15045FS



Code pour roue avec bague revêtue

LGX15045BRFS



Code pour roue avec double bague autolubrifiante BT

-



Code pour roue avec double roulement à billes HT

-

