

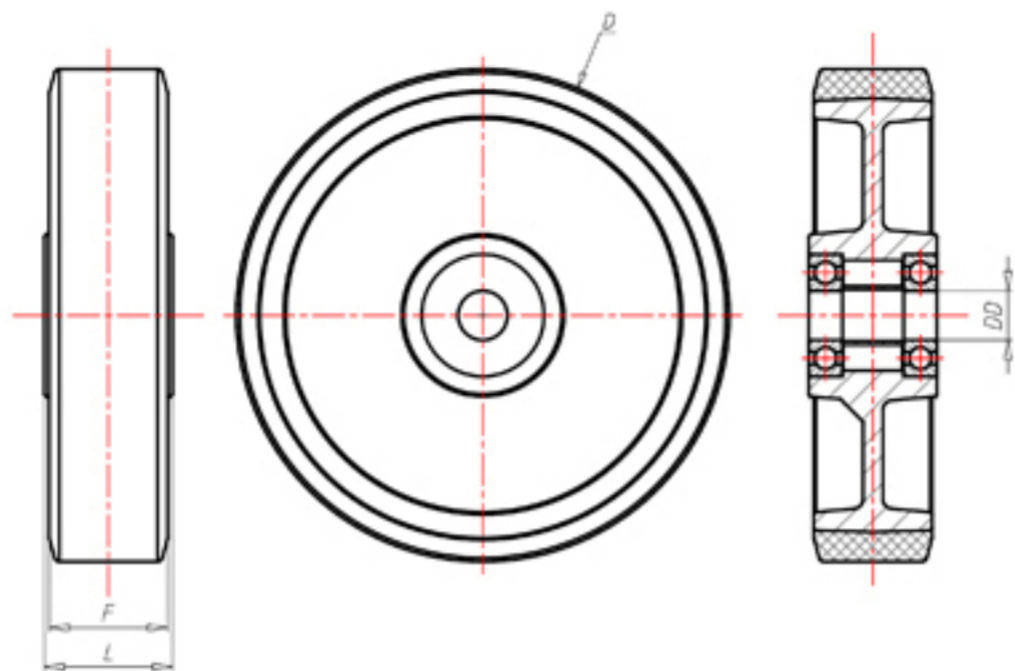

+260°C  
-40°C



	D	80
	F	30
	L	40
	DD	Ø 12
	LC	100



Code pour roue à alésage lisse

RHT80



Code pour roue avec bague revêtue

-



Code pour roue avec double bague autolubrifiante BT

-



Code pour roue avec double roulement à billes HT

RHT80C

