

**DITHERM
RHT**

+260°C
-40°C

INOX

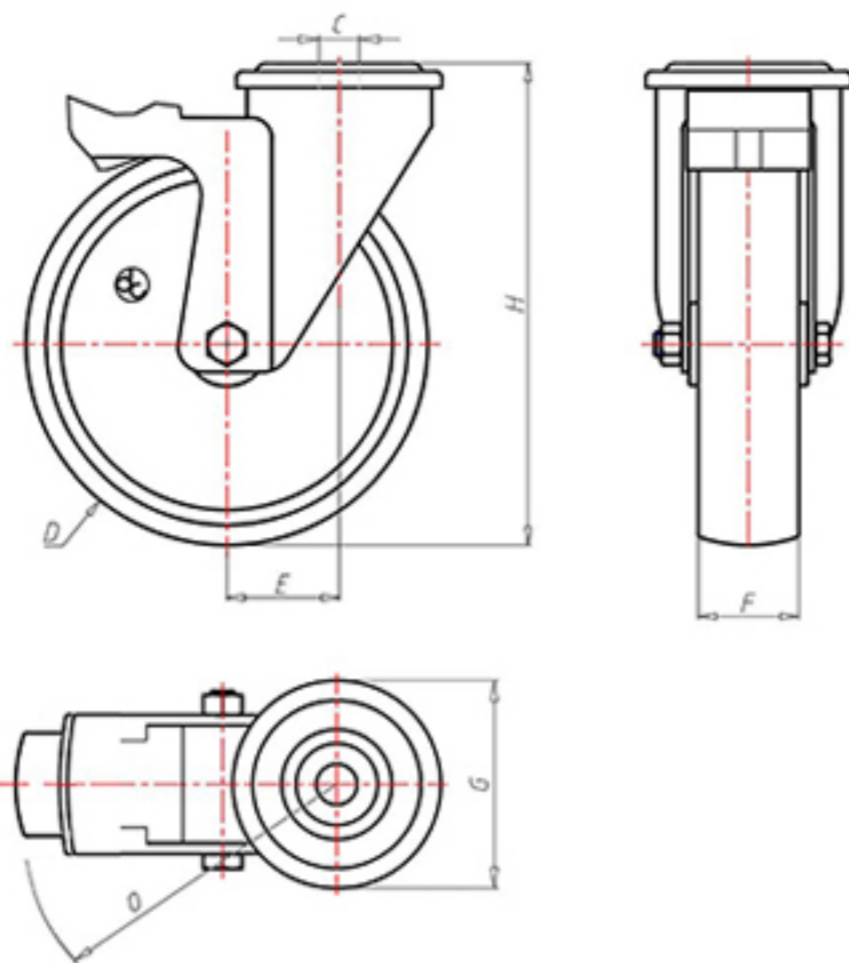

	D	100
	F	30
	H	128
	G	Ø 77
	C	Ø 12
	E	42
	O	124
	LC	120



Code pour roue à alésage lisse

RPX100FS



Code pour roue avec bague revêtue

RPX100BRFS



Code pour roue avec double bague autolubrifiante BT

RPX100BTFS



Code pour roue avec double roulement à billes HT

RPX100CFS

