

DITHERM
RHT

+260°C
-40°C

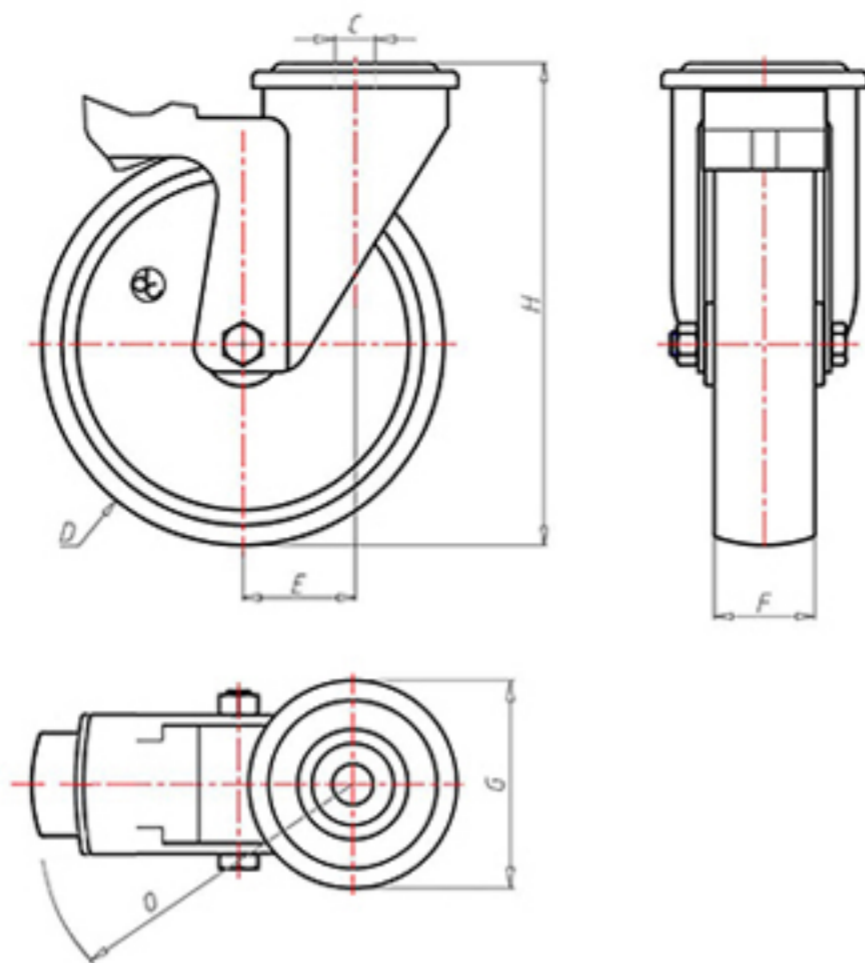

	D	80
	F	30
	H	108
	G	Ø 77
	C	Ø 12
	E	40
	O	124
	LC	100



Code pour roue à alésage lisse

RPZ80FS



Code pour roue avec bague revêtue

RPZ80BRFS



Code pour roue avec double bague autolubrifiante BT

RPZ80BTFS



Code pour roue avec double roulement à billes HT

RPZ80CFS

