

D-NAMIC

92 Shore A
+90°C
-40°C

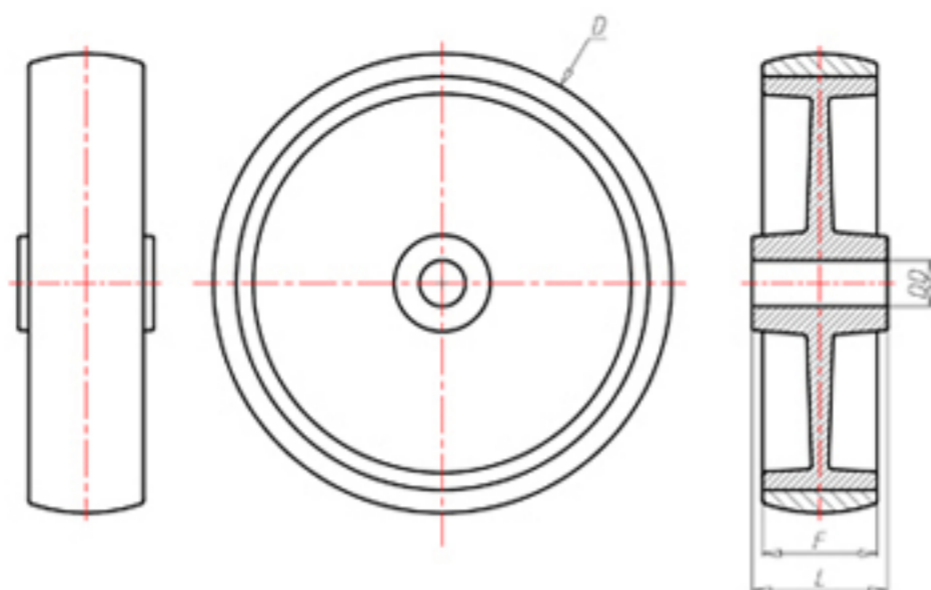

	D	150
	F	40
	L	50
	DD	Ø 20
	LC	500



Codice per ruota a foro passante

-



Codice per ruota con cuscinetto a rulli

-



Codice per ruota con cuscinetto a rulli Inox

-



Codice per ruota con doppio cuscinetto a sfere

PXN15050C



Codice per ruota con doppio cuscinetto a sfere Inox

PXN15050CX

