

D-NAMIC

92 Shore A  
+90°C  
-40°C

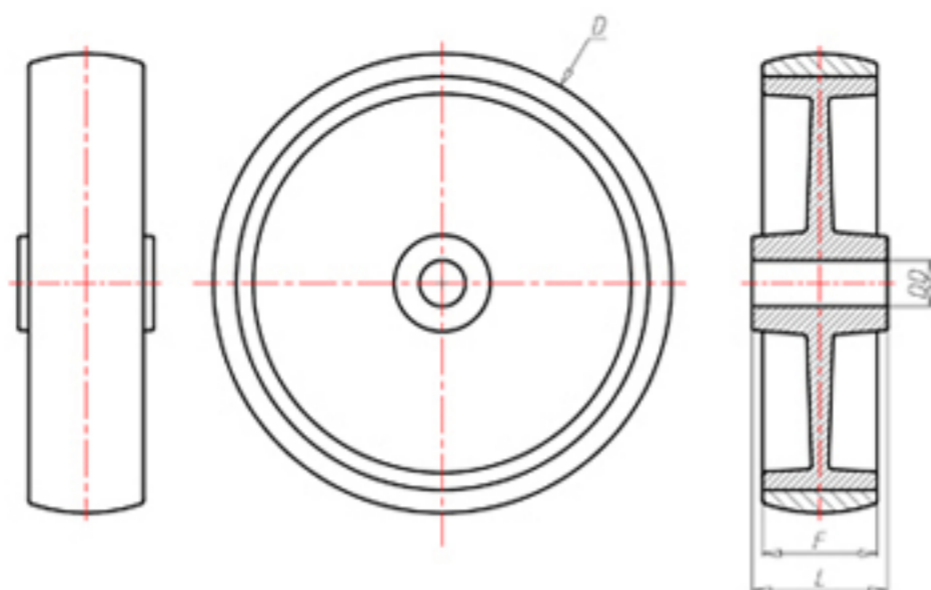

	D	150
	F	40
	L	58
	DD	Ø 20
	LC	500



Codice per ruota a foro passante

PXN15060



Codice per ruota con cuscinetto a rulli

PXN15060R



Codice per ruota con cuscinetto a rulli Inox

PXN15060RX



Codice per ruota con doppio cuscinetto a sfere

-



Codice per ruota con doppio cuscinetto a sfere Inox

-

