

D-NAMIC

92 Shore A
+90°C
-40°C

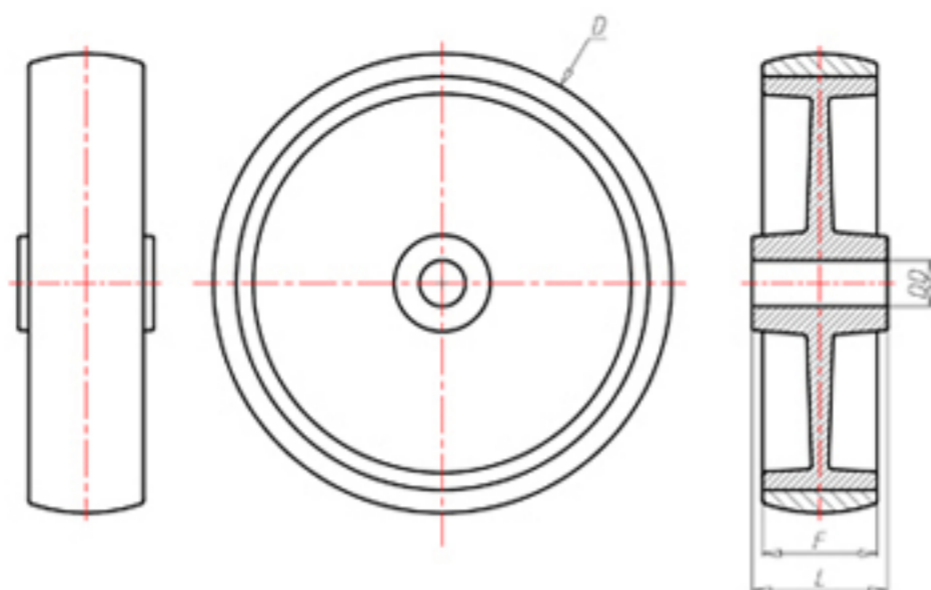

	D	200
	F	40
	L	58
	DD	Ø 20
	LC	700



Codice per ruota a foro passante

PXN20060



Codice per ruota con cuscinetto a rulli

PXN20060R



Codice per ruota con cuscinetto a rulli Inox

PXN20060RX



Codice per ruota con doppio cuscinetto a sfere

-



Codice per ruota con doppio cuscinetto a sfere Inox

-

