

D-NAMIC

92 Shore A  
+90°C  
-40°C

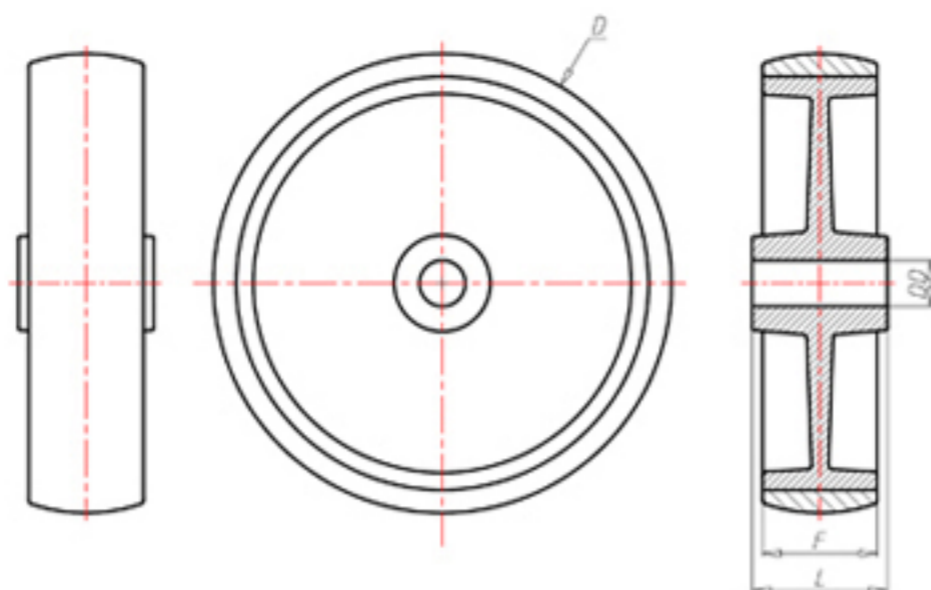

	D	80
	F	33
	L	45
	DD	Ø 12
	LC	240



Codice per ruota a foro passante

PXN8045



Codice per ruota con cuscinetto a rulli

PXN8045R



Codice per ruota con cuscinetto a rulli Inox

PXN8045RX



Codice per ruota con doppio cuscinetto a sfere

-



Codice per ruota con doppio cuscinetto a sfere Inox

-

