

**DITHERM
STW**

+280°C
-70°C

INOX

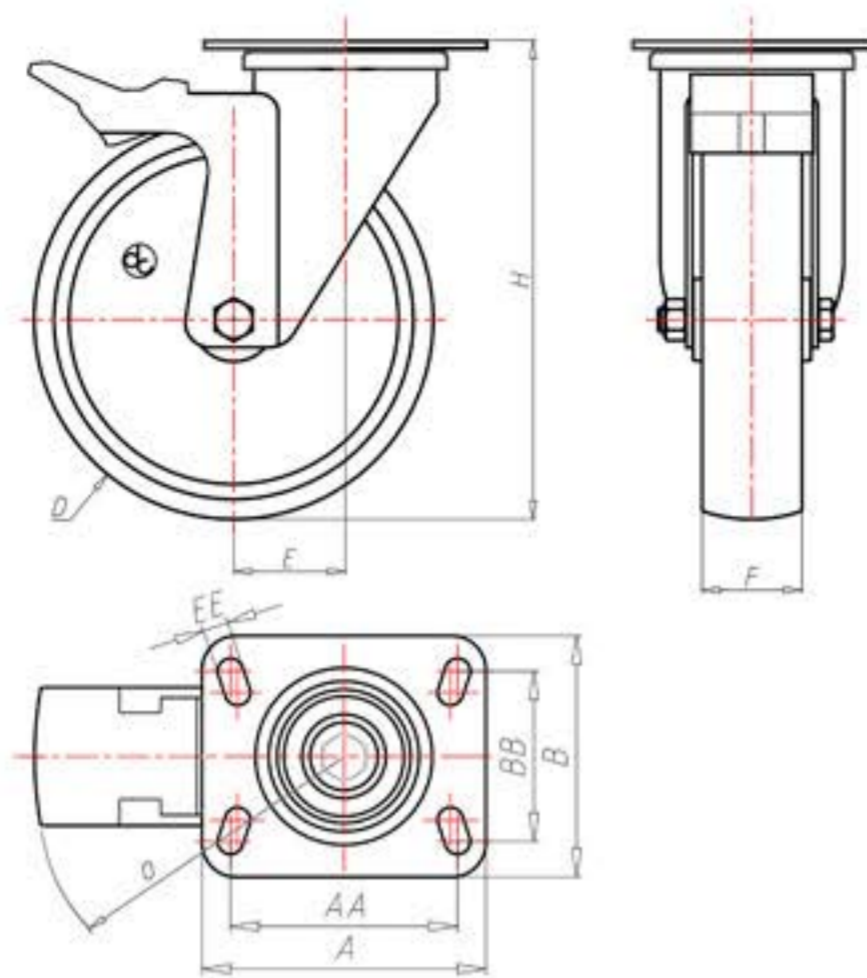

	D	80
	F	30
	H	108
	AxB	100x85
	AAxBB	80x60
	EE	9
	E	40
	O	124
	LC	230



Codice per ruota a foro passante

SGX80PFA



Codice per ruota con bussola rivestita in HQS

SGX80PBRFA



Codice per ruota con doppia boccola autolubrificante in HQS

SGX80PBTFA



Codice per ruota con doppio cuscinetto a sfere HT

SGX80PCFA

