

**DITHERM
STW**

+280°C
-70°C

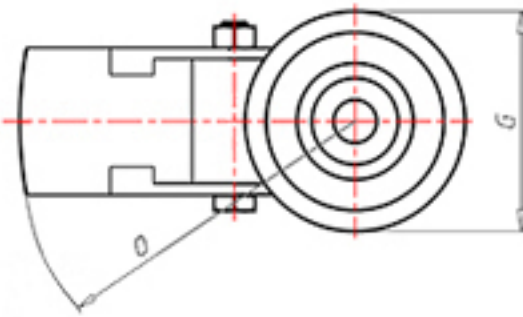

	D	150
	F	40
	H	181
	G	Ø 77
	C	Ø 12
	E	46
	O	124
	LC	250

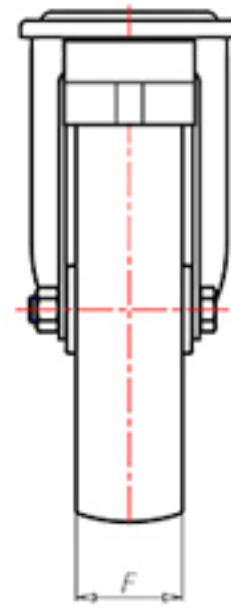
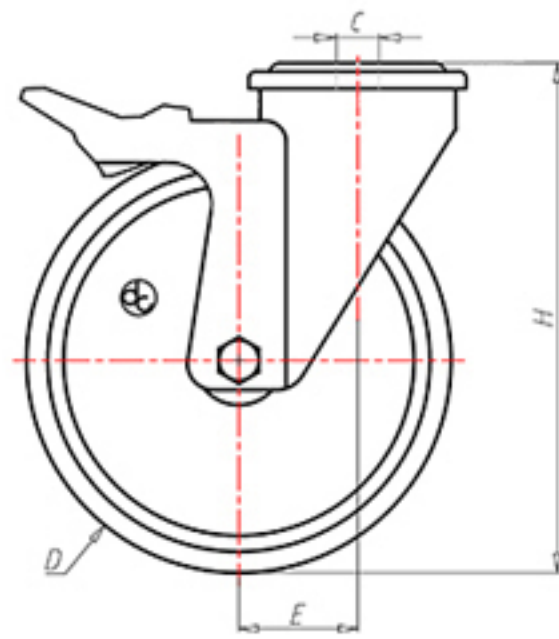

Codice per ruota a foro passante

SPZ15045FA



Codice per ruota con bussola rivestita in HQS

SPZ15045BRFA



Codice per ruota con doppia boccola autolubrificante in HQS

-



Codice per ruota con doppio cuscinetto a sfere HT

-

