

**DITHERM
STW**

+280°C
-70°C

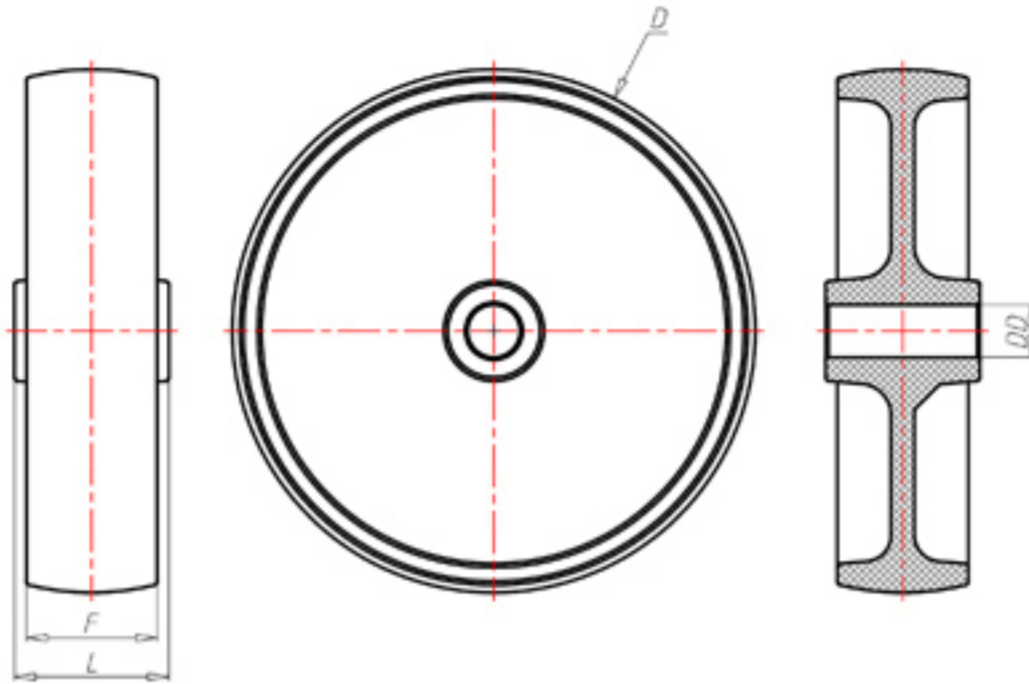

	D	80
	F	30
	L	45
	DD	Ø 10
	LC	300

Codice per ruota a foro passante

-



Codice per ruota con bussola rivestita in HQS

-



Codice per ruota con doppia boccola autolubrificante in HQS

STW80BT



Codice per ruota con doppio cuscinetto a sfere HT

-



Codice per ruota con doppia boccola in bronzo sinterizzato

-

