

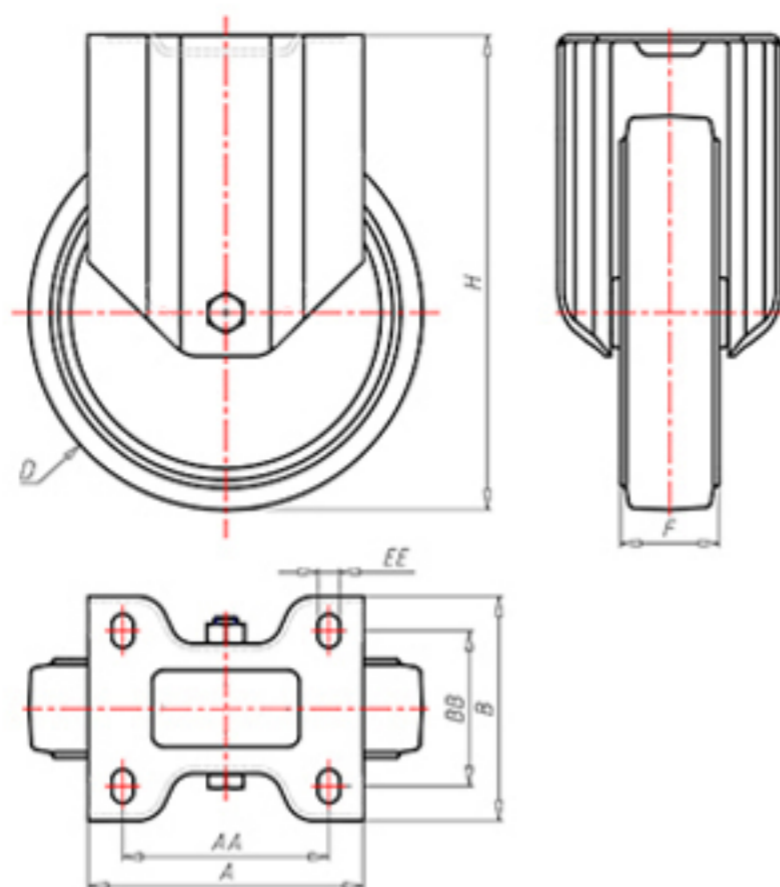

+150°C
-40°C



	D	150
	F	40
	H	181
	AxB	135x110
	AAxBB	105x80
	EE	11
	LC	380



Код с подшипник скольжения

LFZ15060



Код с втулки с тефлоновым покрытием

-



Код с 2 тефлоновые буксы

-



Код с двойной термостойкий шарикоподшипник

-

