

**DITHERM
LTW**

+150°C
-40°C

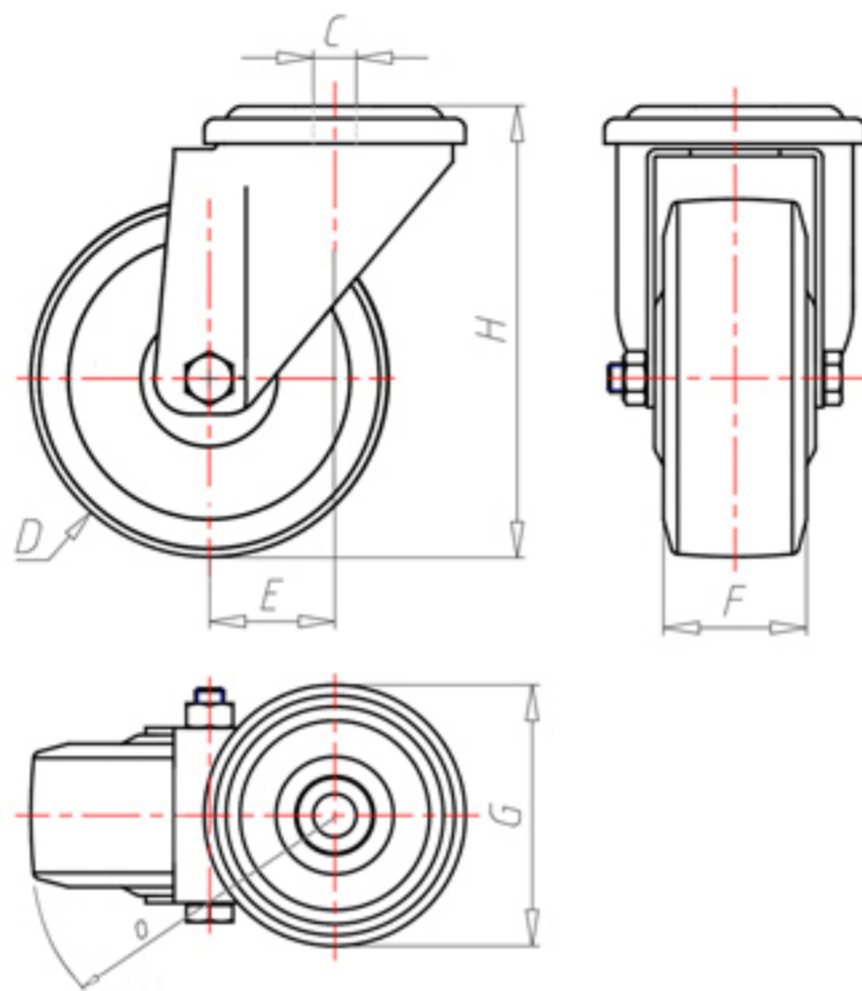

	D	80
	F	35
	H	108
	G	Ø 77
	C	Ø 12
	E	40
	O	82
	LC	200



Код с подшипник скольжения

LPZ8040



Код с втулки с тефлоновым покрытием

LPZ8040BR



Код с 2 тефлоновые буксы

LPZ8040BT



Код с двойной термостойкий шарикоподшипник

-

