

**DITHERM
RHT**

+260°C
-40°C

INOX

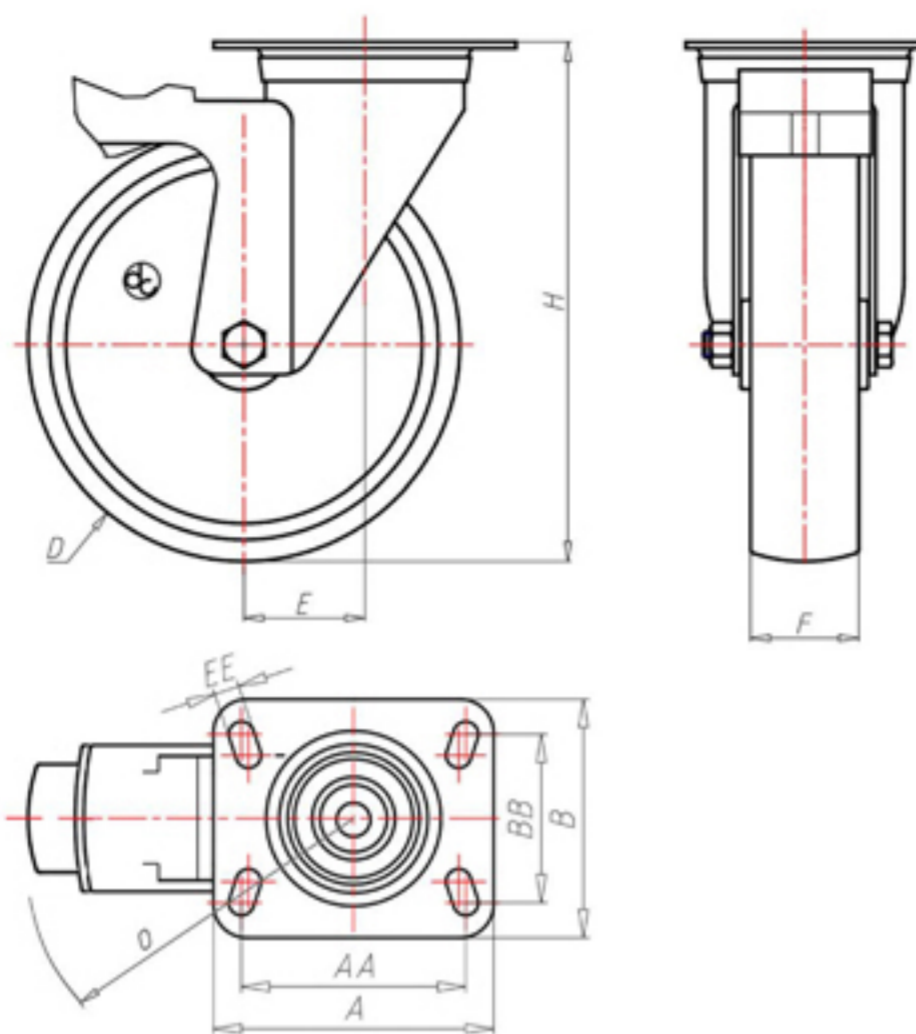

	D	100
	F	30
	H	128
	AxB	100x85
	AAxBB	80x60
	EE	9
	E	42
	O	124
	LC	120



Код с подшипник скольжения

RGX100FS



Код с втулки с тефлоновым покрытием

RGX100BRFS



Код с 2 тефлоновые буксы

RGX100BTFS



Код с двойной термостойкий шарикоподшипник

RGX100CFS

