

**DITHERM  
RHT**

+260°C  
-40°C

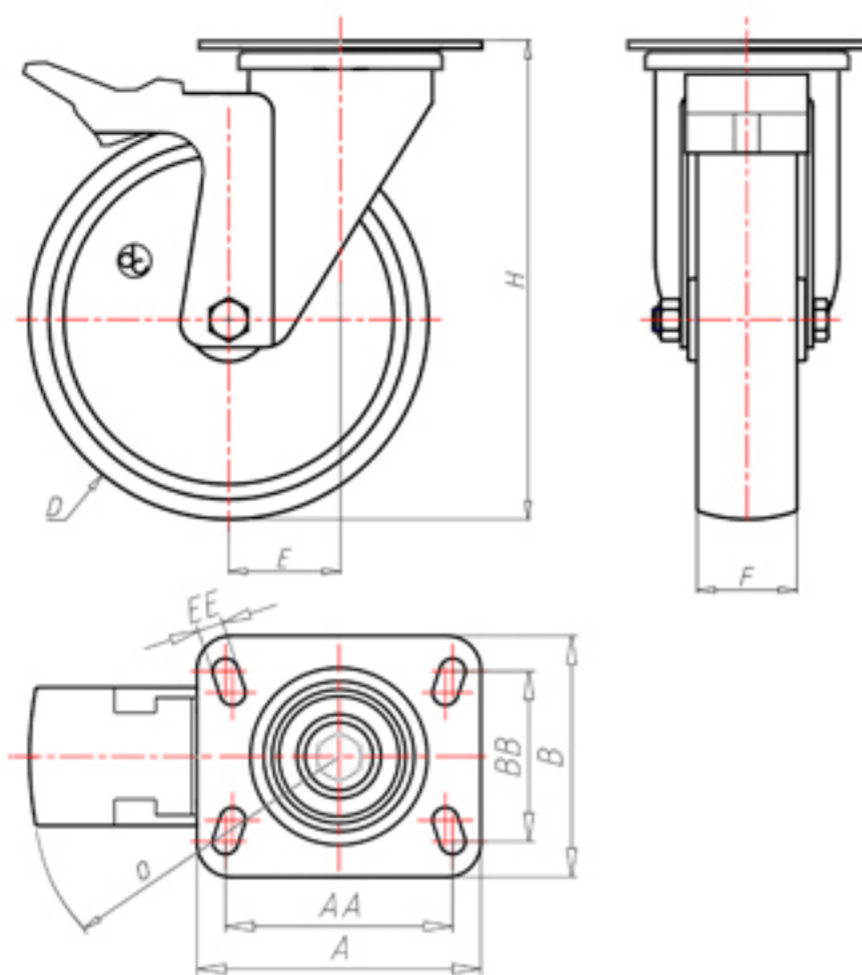

|  |       |        |
|--|-------|--------|
|  | D     | 80     |
|  | F     | 30     |
|  | H     | 108    |
|  | AxB   | 100x85 |
|  | AAxBB | 80x60  |
|  | EE    | 9      |
|  | E     | 40     |
|  | O     | 124    |
|  | LC    | 100    |



Код с подшипник скольжения

**RGZ80FA**



Код с втулки с тефлоновым покрытием

**RGZ80BRFA**



Код с 2 тефлоновые буксы

**RGZ80BTFA**



Код с двойной термостойкий шарикоподшипник

**RGZ80CFA**

