

**DITHERM
RHT**

+260°C
-40°C

INOX

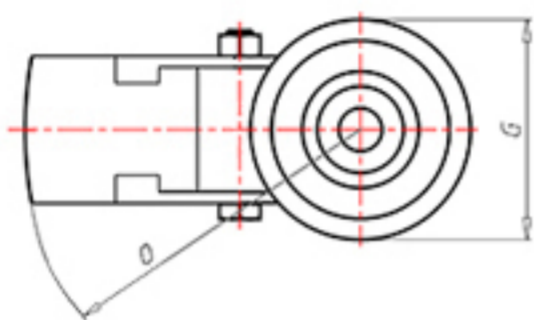
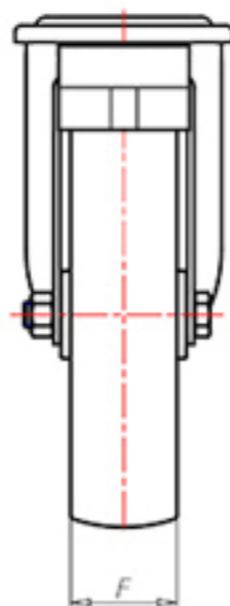
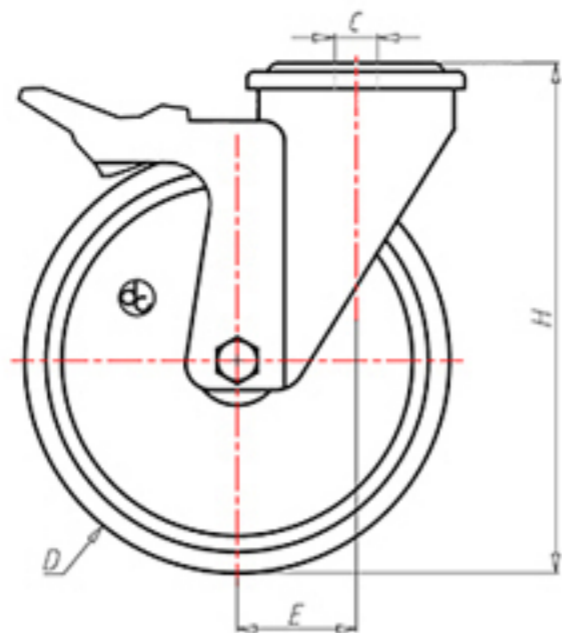

	D	80
	F	30
	H	108
	G	Ø 77
	C	Ø 12
	E	40
	O	124
	LC	100



Код с подшипник скольжения

RPX80FA



Код с втулки с тефлоновым покрытием

RPX80BRFA



Код с 2 тефлоновые буксы

RPX80BTFA



Код с двойной термостойкий шарикоподшипник

RPX80CFA

