

DITHERM
RHT

+260°C

-40°C

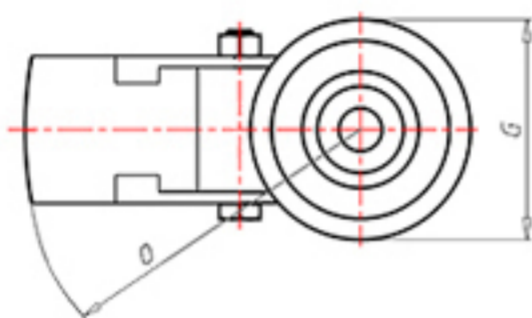
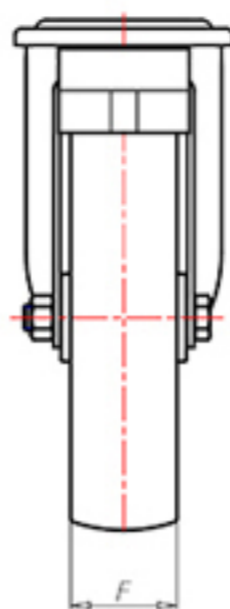
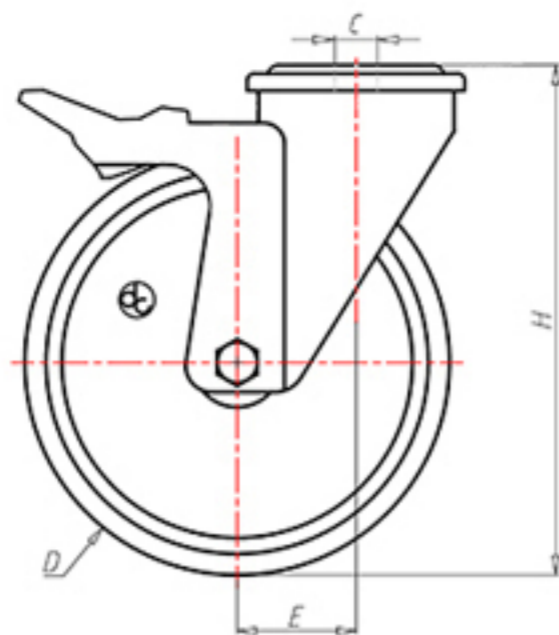

	D	80
	F	30
	H	108
	G	Ø 77
	C	Ø 12
	E	40
	O	124
	LC	100



Код с подшипник скольжения

RPZ80FA



Код с втулки с тефлоновым покрытием

RPZ80BRFA



Код с 2 тефлоновые буксы

RPZ80BTFA



Код с двойной термостойкий шарикоподшипник

RPZ80CFA

