

**DITHERM
STW**

+280°C
-70°C

INOX

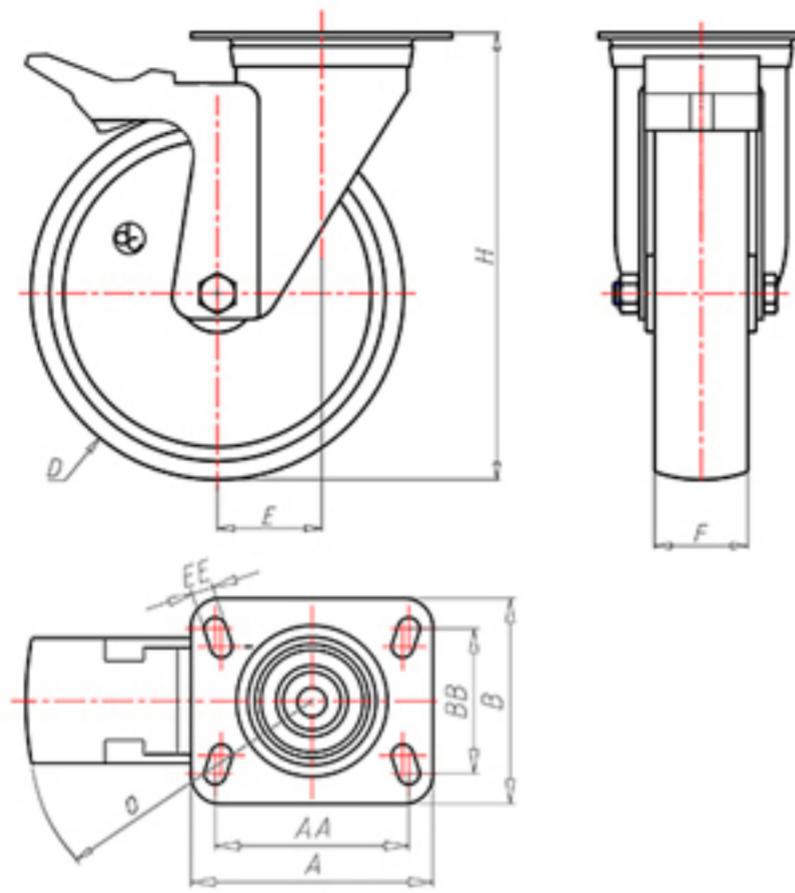

	D	200
	F	50
	H	232
	AxB	135x110
	AAxBB	105x80
	EE	9
	E	56
	O	167
	LC	400



Код с подшипник скольжения

SGX20060PFA



Код с втулки с тефлоновым покрытием

-



Код с 2 тефлоновые буксы

-



Код с двойной термостойкий шарикоподшипник

-

