

**DITHERM
STW**

+280°C
-70°C

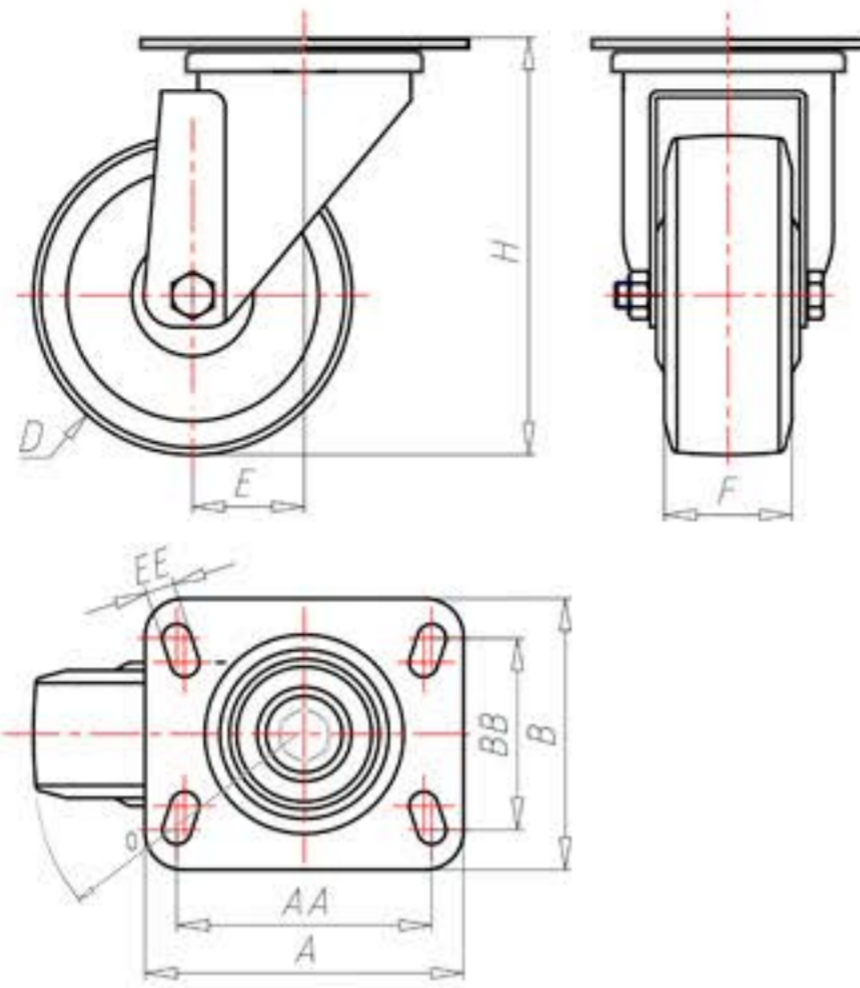

	D	80
	F	30
	H	110
	AxB	100x85
	AAxBB	80x60
	EE	9
	E	40
	O	82
	LC	230



Код с подшипник скольжения

SGZ80P



Код с втулки с тефлоновым покрытием

SGZ80PBR



Код с 2 тефлоновые буксы

SGZ80PBT



Код с двойной термостойкий шарикоподшипник

SGZ80PC

