

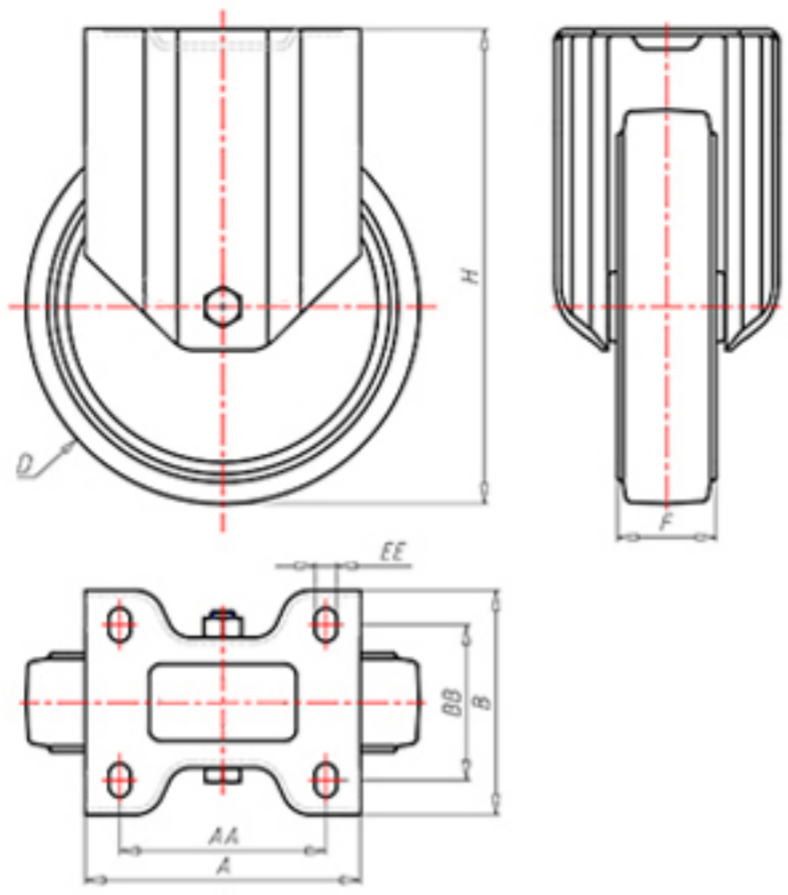







72 Shore A
 +80°C
 -40°C



	D	100
	F	33
	H	128
	AxB	100x85
	AAxBB	80x60
	EE	9
	LC	180



Code for plain bore wheel

ACFZ10045



Code for wheel with roller bearing

ACFZ10045R

