

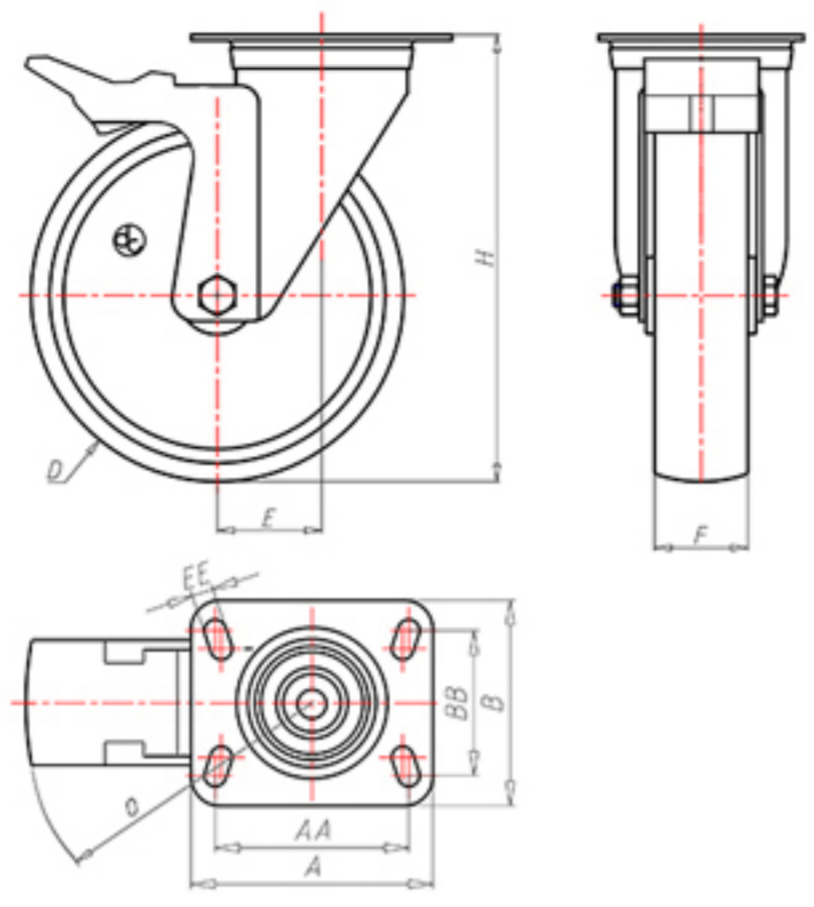









72 Shore A
 +80°C
 -40°C



| | | |
|--|-------|--------|
|  | D | 100 |
|  | F | 33 |
|  | H | 128 |
|  | AxB | 100x85 |
|  | AAxBB | 80x60 |
|  | EE | 9 |
|  | E | 42 |
|  | O | 124 |
|  | LC | 180 |



Code for plain bore wheel

ACGZ10045PFA

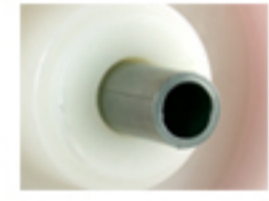

Code for wheel with roller bearing

ACGZ10045PRFA

