

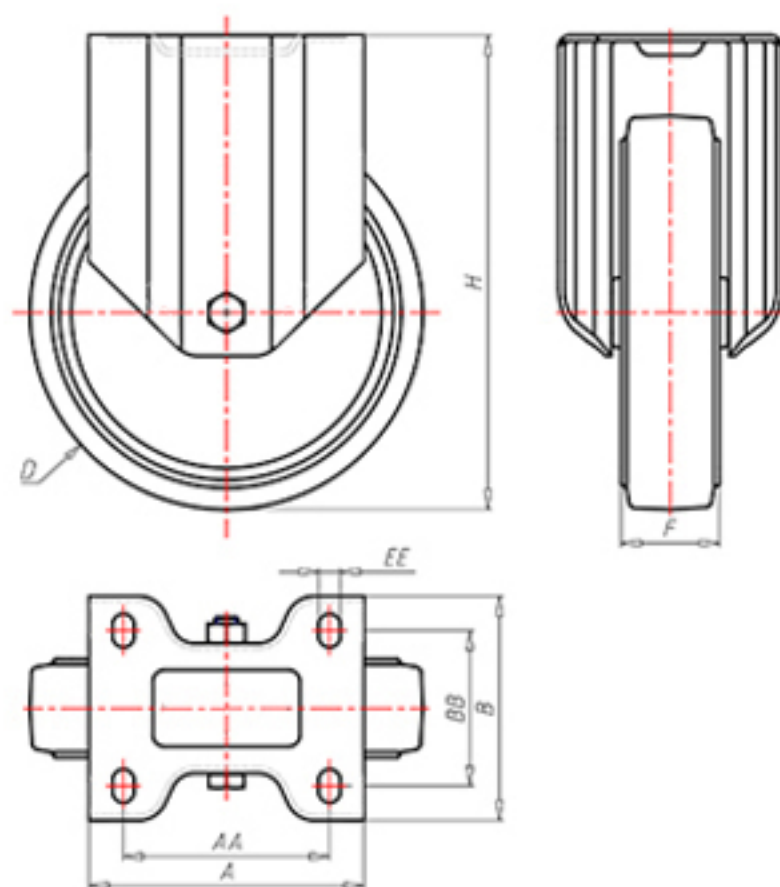

+150°C
-40°C



	D	125
	F	40
	H	155
	AxB	100x85
	AAxBB	80x60
	EE	9
	LC	260



Code for plain bore wheel

LFZ12545



Code for wheel with coated bush

LFZ12545BR



Code for wheel with double BT self-lube bush

-



Code for wheel with double HT ball bearing

-

