

**DITHERM
LTW**

+150°C
-40°C

INOX

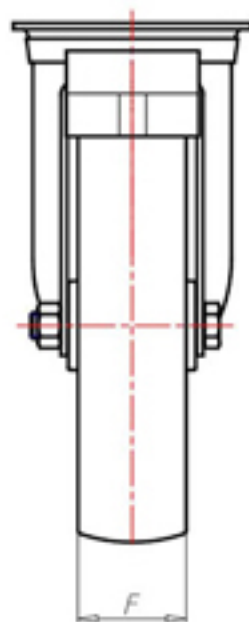
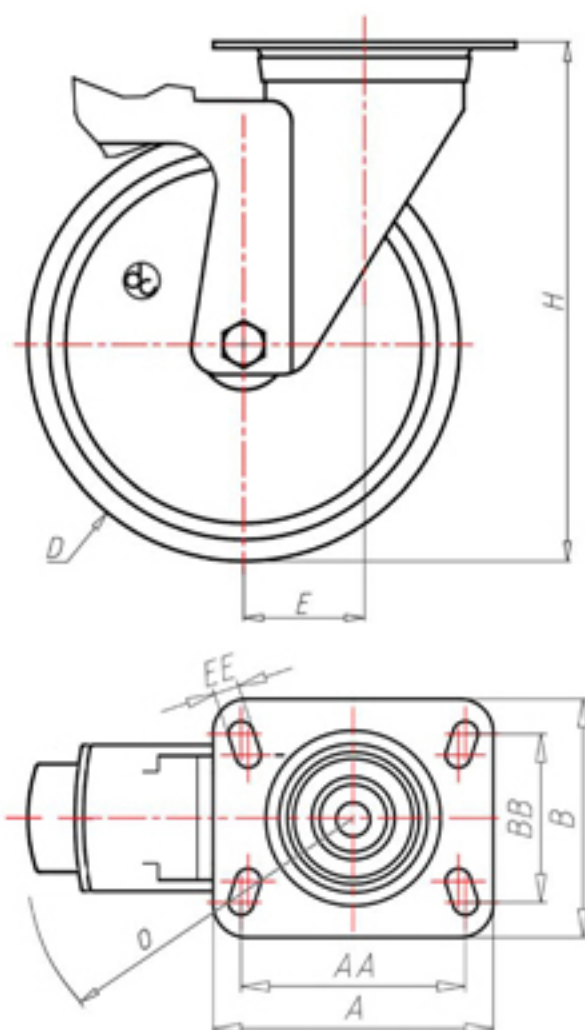

	D	150
	F	40
	H	181
	AxA	100x85
	AAxBB	80x60
	EE	9
	E	46
	O	124
	LC	250



Code for plain bore wheel

LGX15045FS



Code for wheel with coated bush

LGX15045BRFS



Code for wheel with double BT self-lube bush

-



Code for wheel with double HT ball bearing

-

