

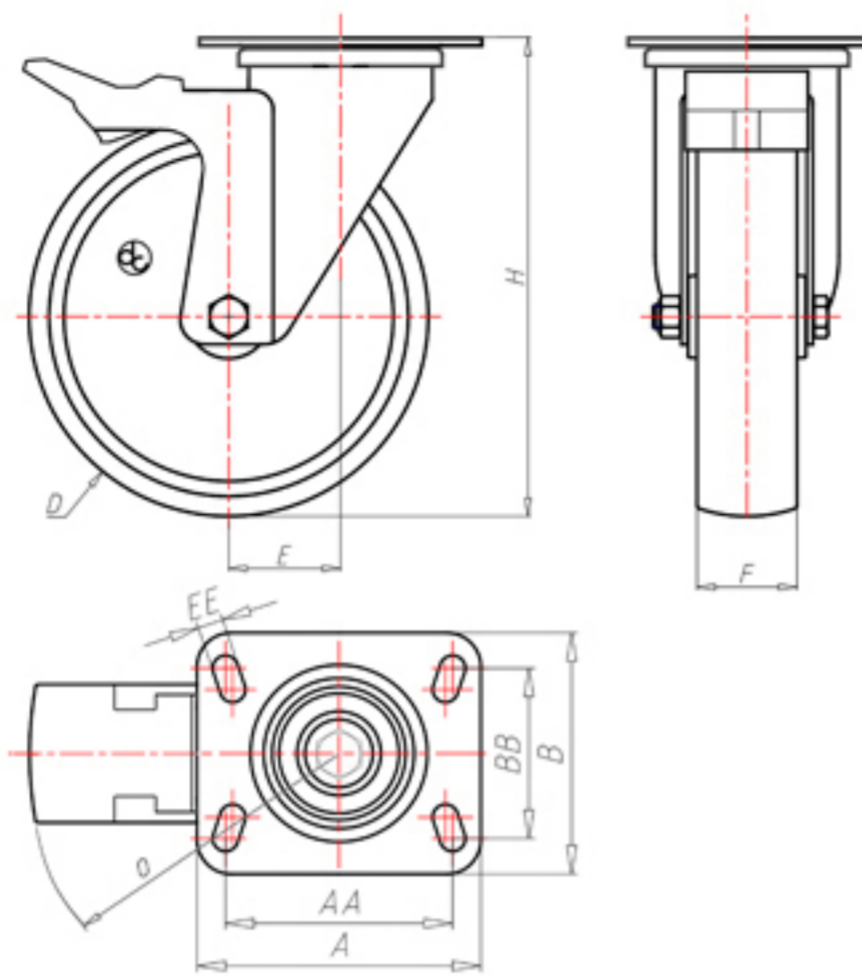

+150°C
-40°C



	D	200
	F	50
	H	235
	AxA	135x110
	AAxBB	105x80
	EE	11
	E	56
	O	167
	LC	500



Code for plain bore wheel

LGZ20060PFA



Code for wheel with coated bush

-



Code for wheel with double BT self-lube bush

-



Code for wheel with double HT ball bearing

-

