

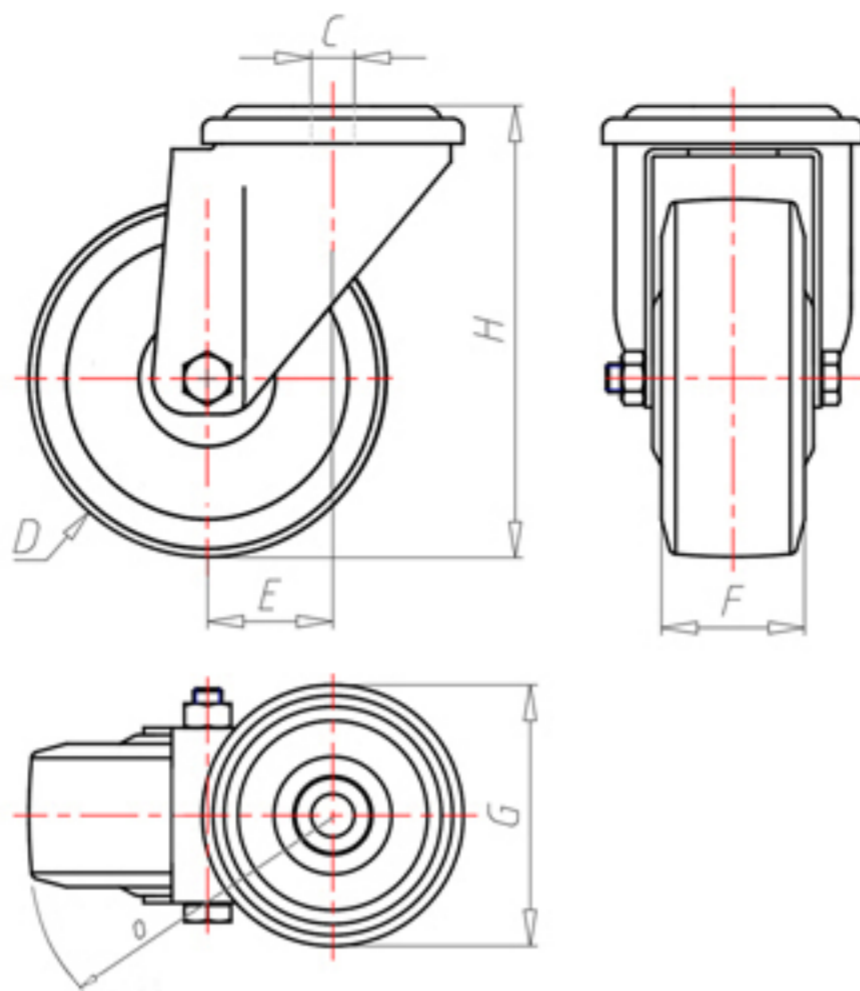

+150°C
-40°C



	D	200
	F	50
	H	232
	G	Ø 102
	C	Ø 16
	E	56
	O	152
	LC	400



Code for plain bore wheel

LPZ20060



Code for wheel with coated bush

-



Code for wheel with double BT self-lube bush

-



Code for wheel with double HT ball bearing

-

