

**DITHERM
MTW**

+300°C
-40°C

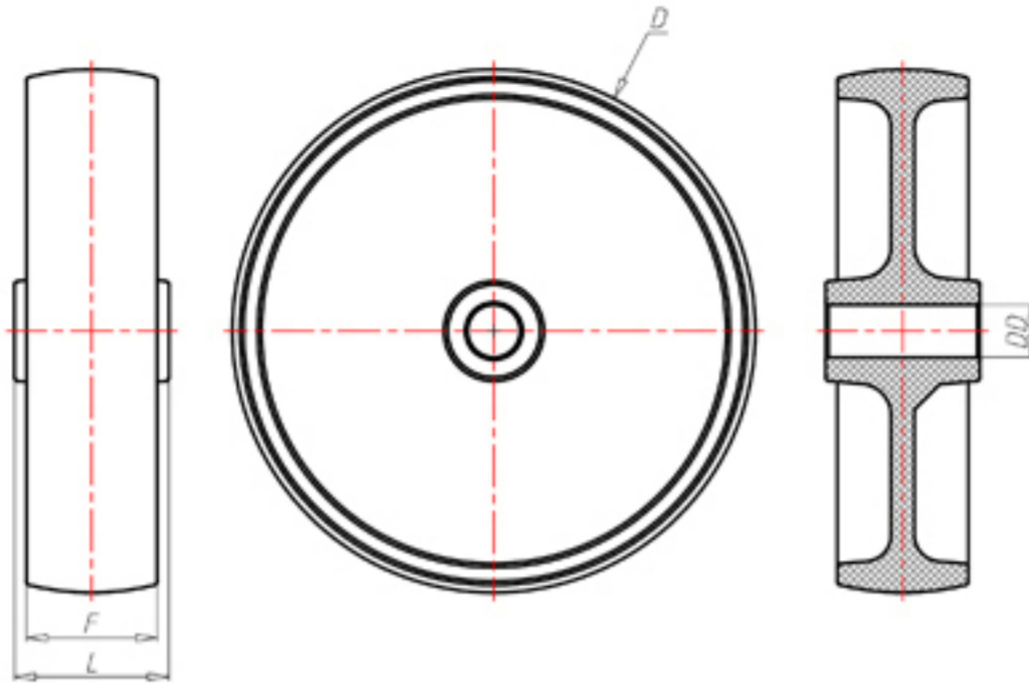

| | | |
|--|----|------|
| | D | 160 |
| | F | 50 |
| | L | 58 |
| | DD | Ø 20 |
| | LC | 340 |



Code for plain bore wheel

MTW160



Code for wheel with coated bush

-



Code for wheel with double BT self-lube bush

-



Code for wheel with double HT ball bearing

-



Code wheel with double sintered bronze bush

-

