

**DITHERM
MTW**

+300°C
-40°C

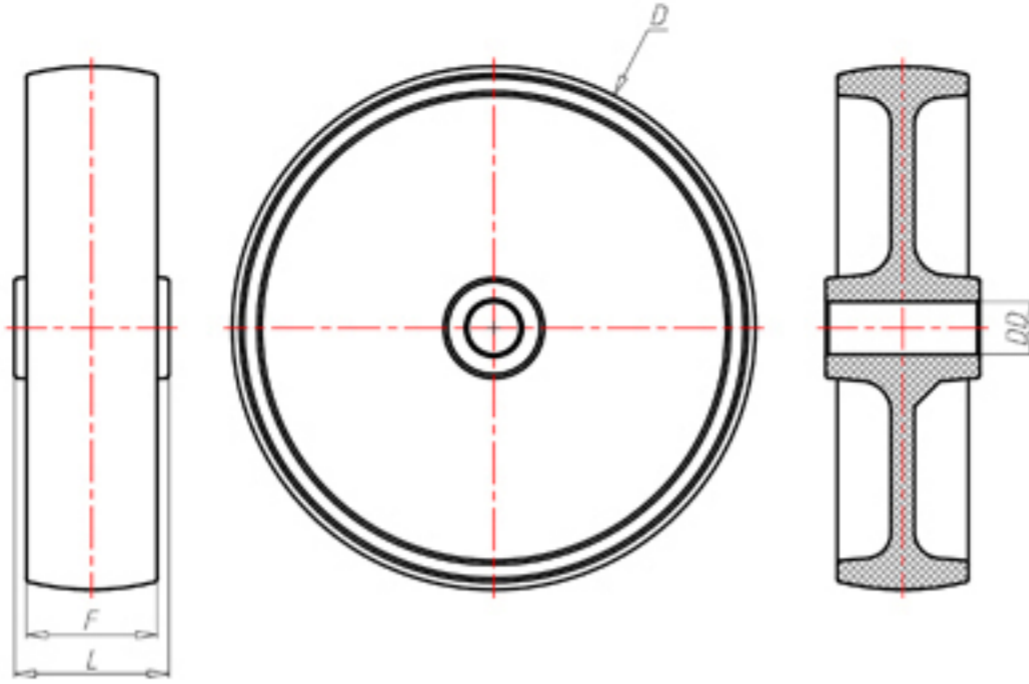

	D	200
	F	50
	L	58
	DD	Ø 20
	LC	520



Code for plain bore wheel

-



Code for wheel with coated bush

-



Code for wheel with double BT self-lube bush

-



Code for wheel with double HT ball bearing

-



Code wheel with double sintered bronze bush

MTW200BS

