

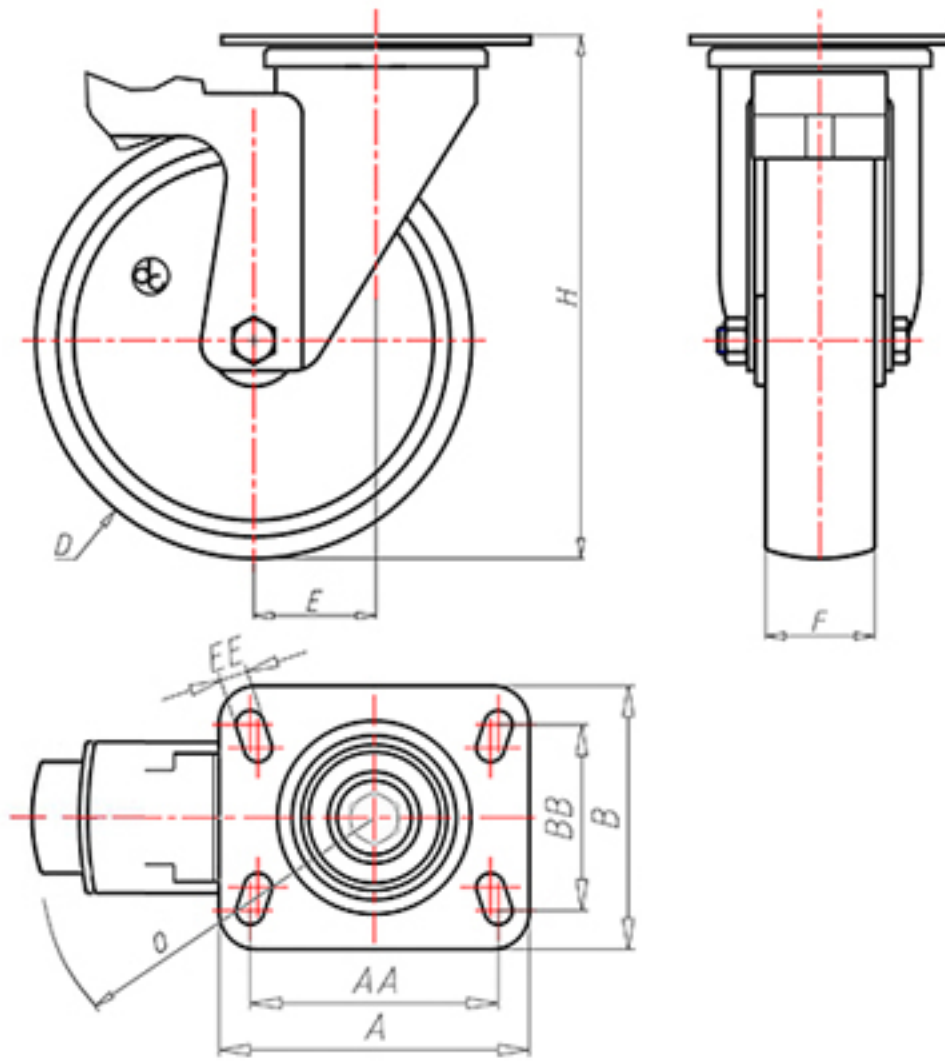

70 Shore D  
+90°C  
-40°C



	D	150
	F	40
	H	184
	AxB	100x85
	AAxBB	80x60
	EE	9
	E	46
	O	124
	LC	280



Code for plain bore wheel

**NYGX15045PFS**

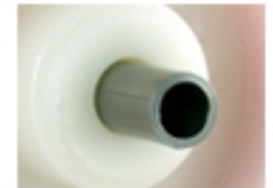

Code for wheel with roller bearing

-



Code for wheel with Inox roller bearing

**NYGX15045PRXFS**

