

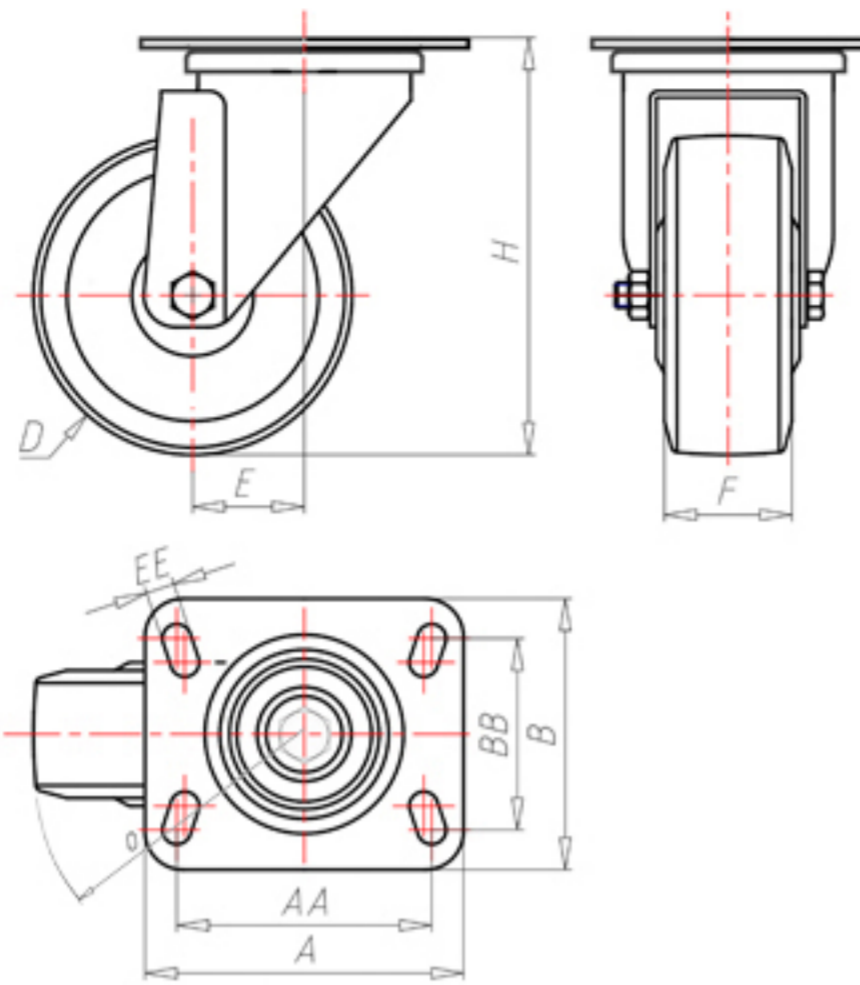

70 Shore D
+90°C
-40°C



	D	150
	F	40
	H	184
	AxB	135x110
	AAxBB	105x80
	EE	11
	E	52
	O	120
	LC	350



Code for plain bore wheel

NYGX15060P



Code for wheel with roller bearing

-



Code for wheel with Inox roller bearing

NYGX15060PRX

