

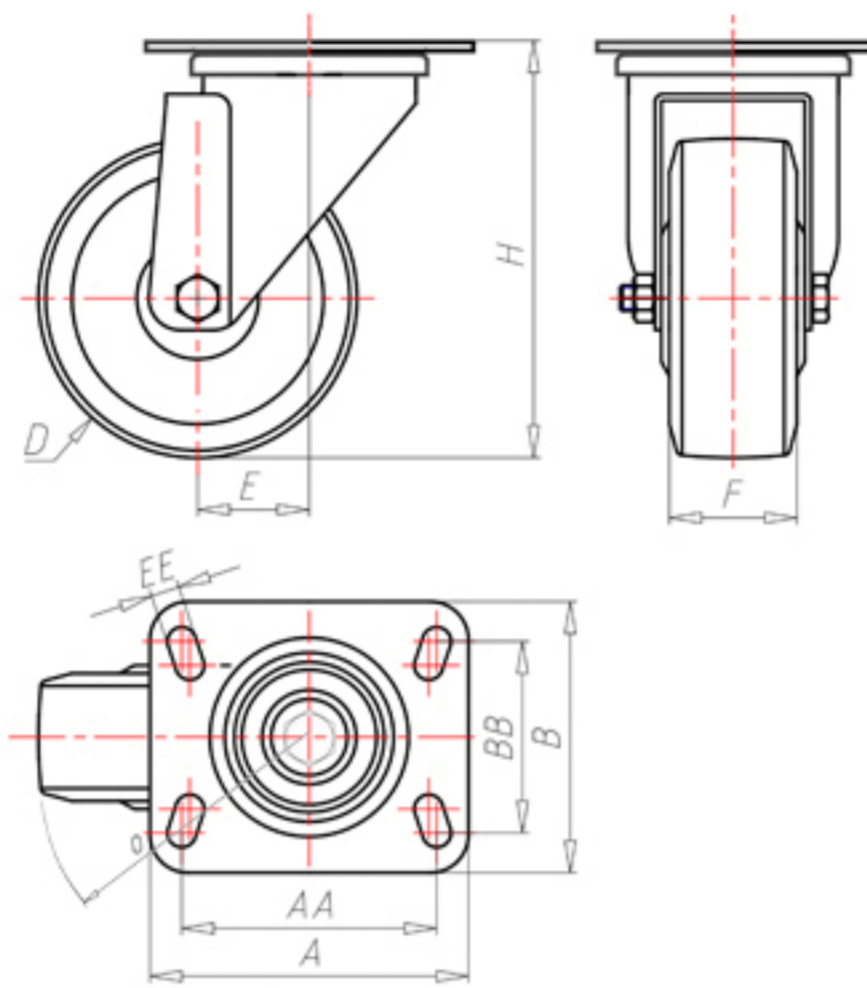

70 Shore D
+90°C
-40°C



	D	200
	F	50
	H	235
	AxB	135x110
	AAxBB	105x80
	EE	11
	E	56
	O	152
	LC	500



Code for plain bore wheel
NYGX20060P



Code for wheel with roller bearing
-



Code for wheel with Inox roller bearing
NYGX20060PRX

