

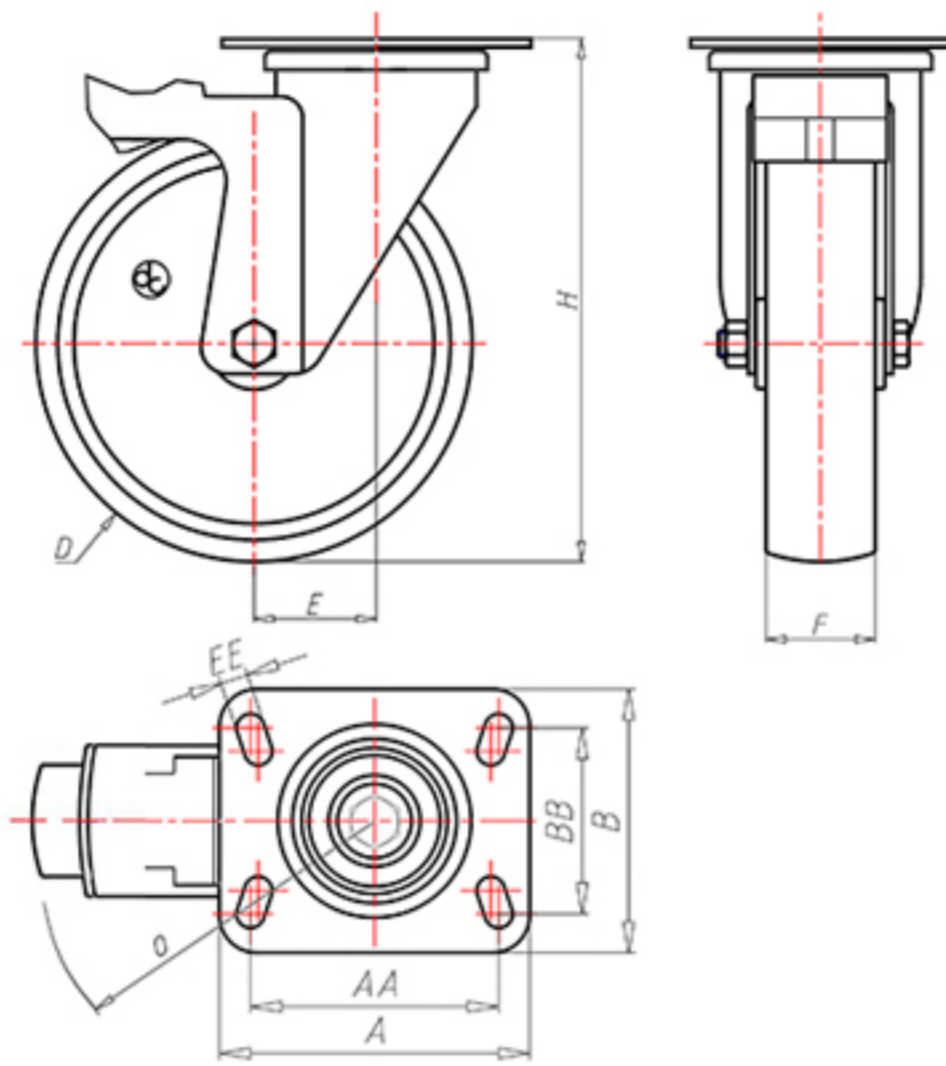

70 Shore D  
+90°C  
-40°C



	D	80
	F	33
	H	110
	AxB	100x85
	AAxBB	80x60
	EE	9
	E	40
	O	124
	LC	210



Code for plain bore wheel

**NYGX8045PFS**

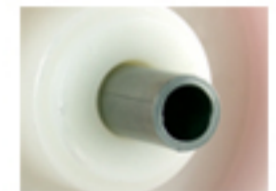

Code for wheel with roller bearing

-



Code for wheel with Inox roller bearing

**NYGX8045PRXFS**

