

D-NAMIC

92 Shore A  
+90°C  
-40°C

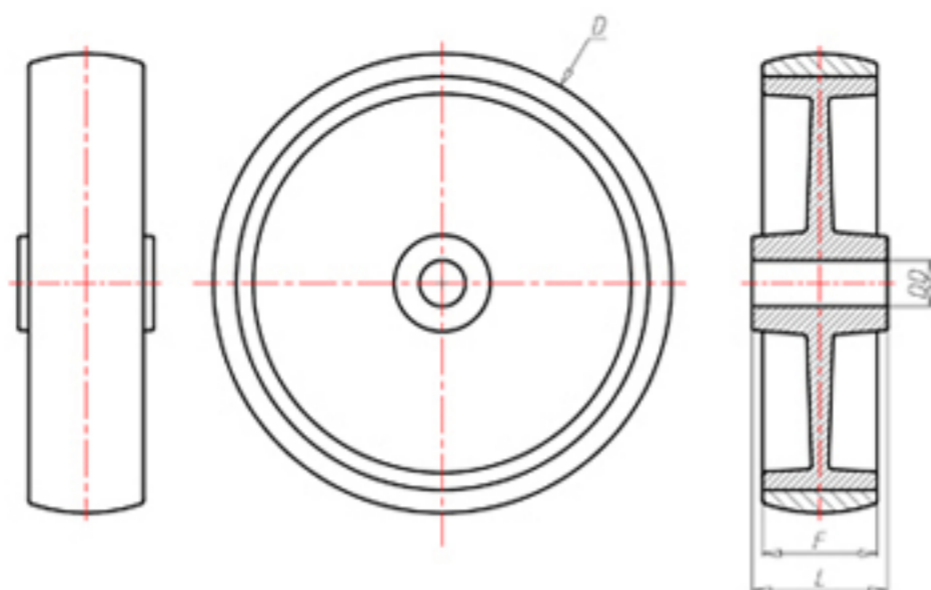

	D	80
	F	33
	L	45
	DD	Ø 12
	LC	240



Code for plain bore wheel

PXN8045



Code for wheel with roller bearing

PXN8045R



Code for wheel with Inox roller bearing

PXN8045RX



Code for wheel with double sealed ball bearing

-



Code for wheel with double sealed Inox ball bearing

-

