

**DITHERM
STW**

+280°C
-70°C

INOX

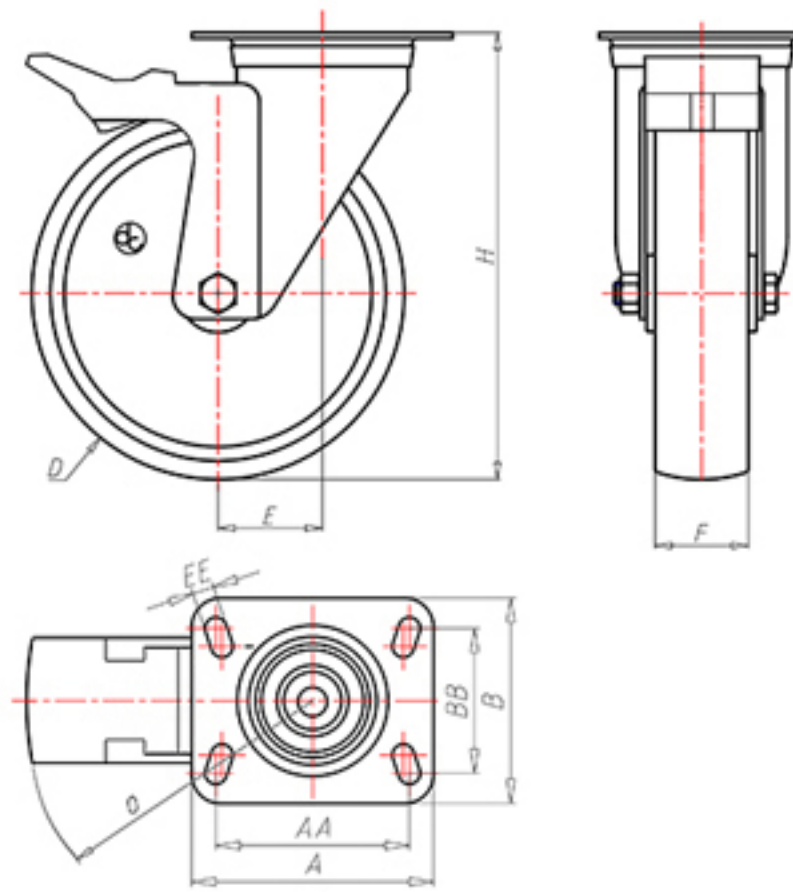

	D	200
	F	50
	H	232
	AxB	135x110
	AAxBB	105x80
	EE	9
	E	56
	O	167
	LC	400



Code for plain bore wheel

SGX20060PFA



Code for wheel with coated bush

-



Code for wheel with double BT self-lube bush

-



Code for wheel with double HT ball bearing

-

