

D-NAMIC

92 Shore A
+90°C
-40°C

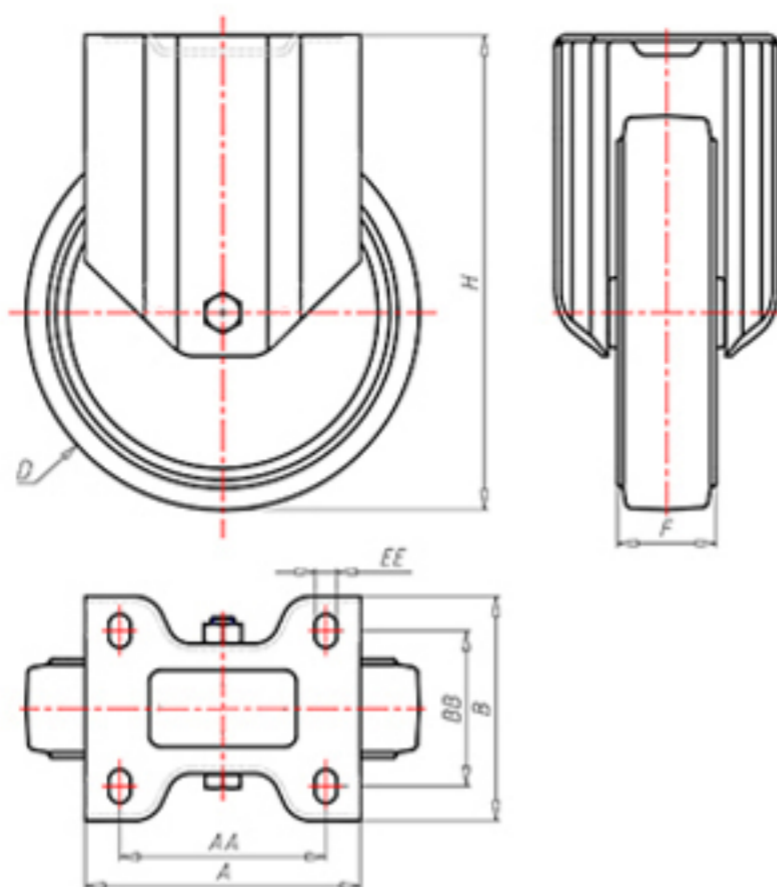

	D	150
	F	40
	H	181
	AxB	135x110
	AAxBB	105x80
	EE	11
	LC	380



Code for plain bore wheel

XNFZ15060



Code for wheel with roller bearing

XNFZ15060R



Code for wheel with double sealed ball bearing

XNFZ15060C



Code for wheel with double sealed Inox ball bearing

-

