

D-NAMIC

92 Shore A
+90°C
-40°C

INOX

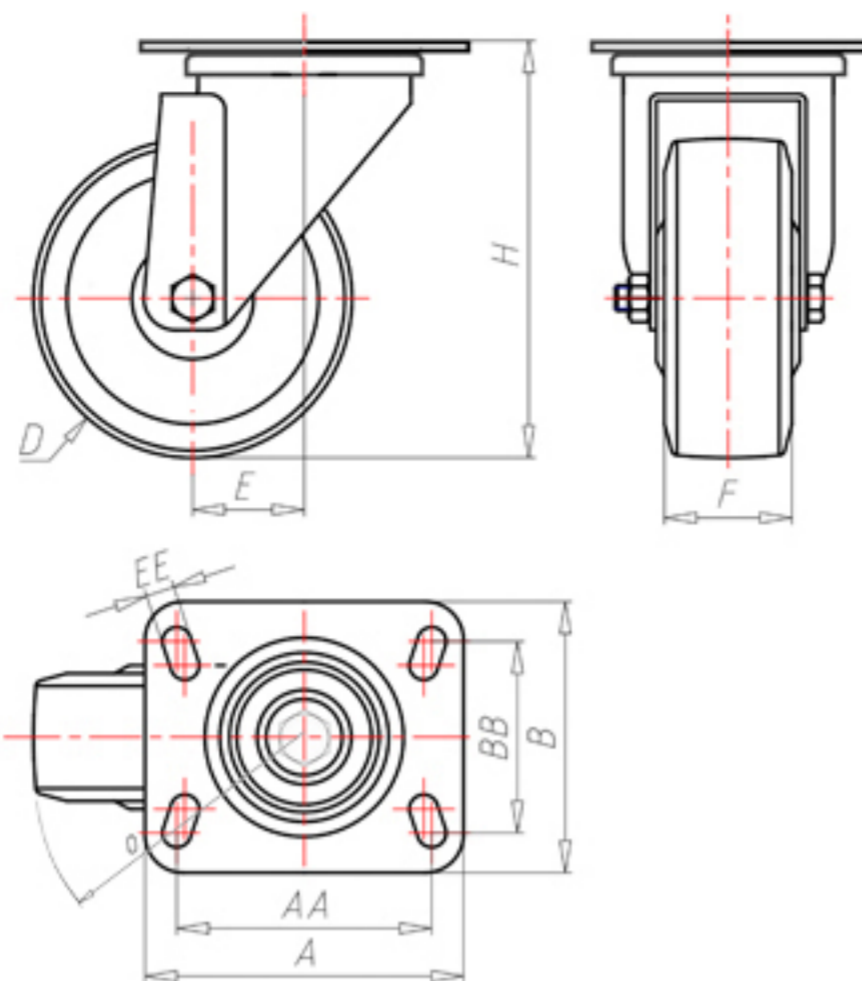

	D	100
	F	33
	H	131
	AxB	100x85
	AAxBB	80x60
	EE	9
	E	42
	O	92
	LC	250



Code for plain bore wheel

XNGX10045P



Code for wheel with Inox roller bearing

XNGX10045PRX



Code for wheel with double sealed ball bearing

XNGX100PC



Code for wheel with double sealed Inox ball bearing

XNGX100PCX

