

D-NAMIC

92 Shore A
+90°C
-40°C

INOX

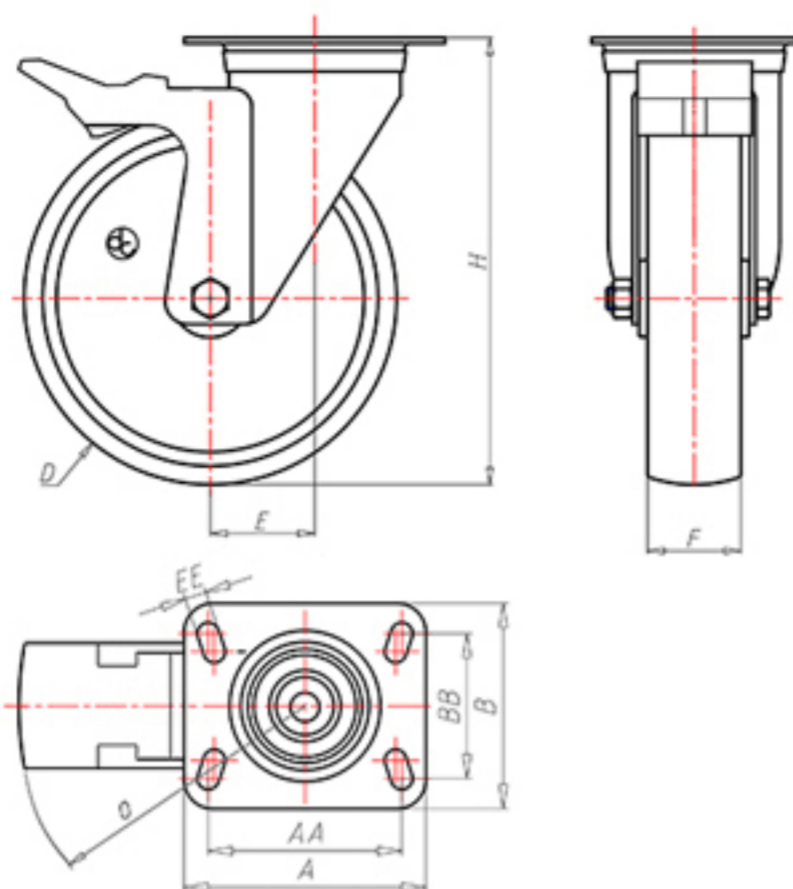

	D	80
	F	33
	H	108
	AxB	100x85
	AAxBB	80x60
	EE	9
	E	40
	O	124
	LC	200



Code for plain bore wheel

XNGX8040FA



Code for wheel with Inox roller bearing

XNGX8040RXFA



Code for wheel with double sealed ball bearing

XNGX8040CFA



Code for wheel with double sealed Inox ball bearing

XNGX8040CXFA

