

D-NAMIC

92 Shore A  
+90°C  
-40°C

INOX

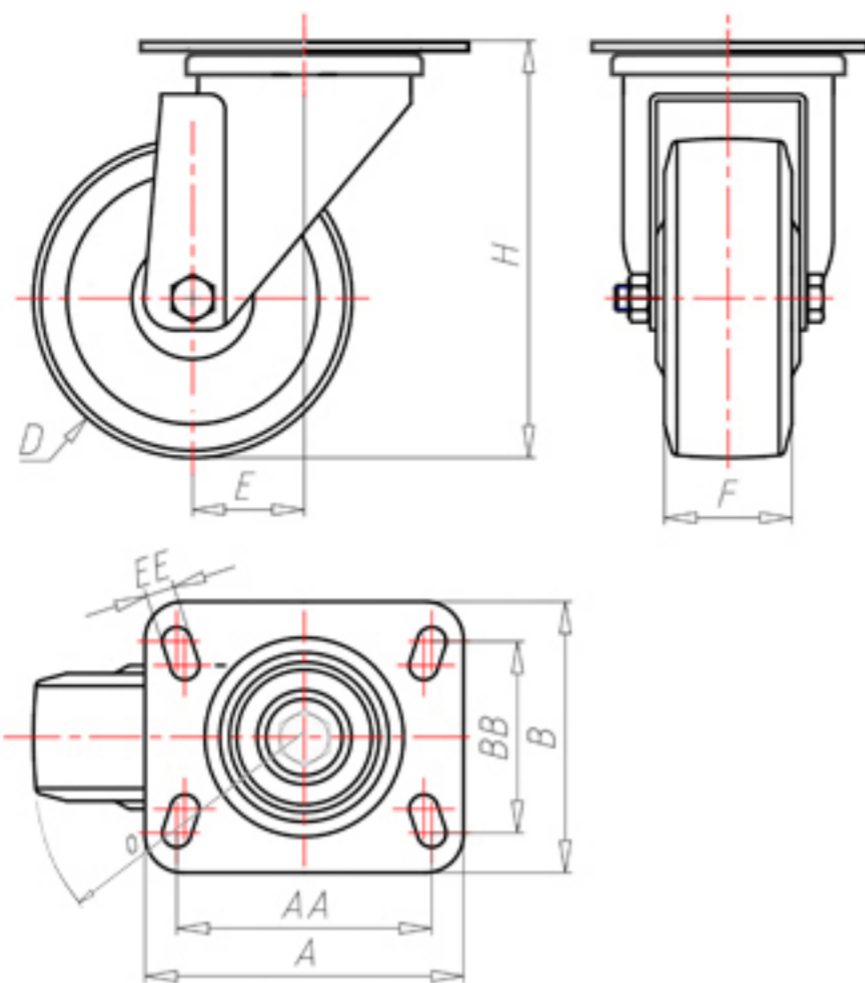

	D	80
	F	33
	H	110
	AxB	100x85
	AAxBB	80x60
	EE	9
	E	40
	O	82
	LC	210



Code for plain bore wheel

XNGX8040P



Code for wheel with Inox roller bearing

XNGX8040PRX



Code for wheel with double sealed ball bearing

XNGX8040PC



Code for wheel with double sealed Inox ball bearing

XNGX8040PCX

