

D-NAMIC

92 Shore A  
+90°C  
-40°C

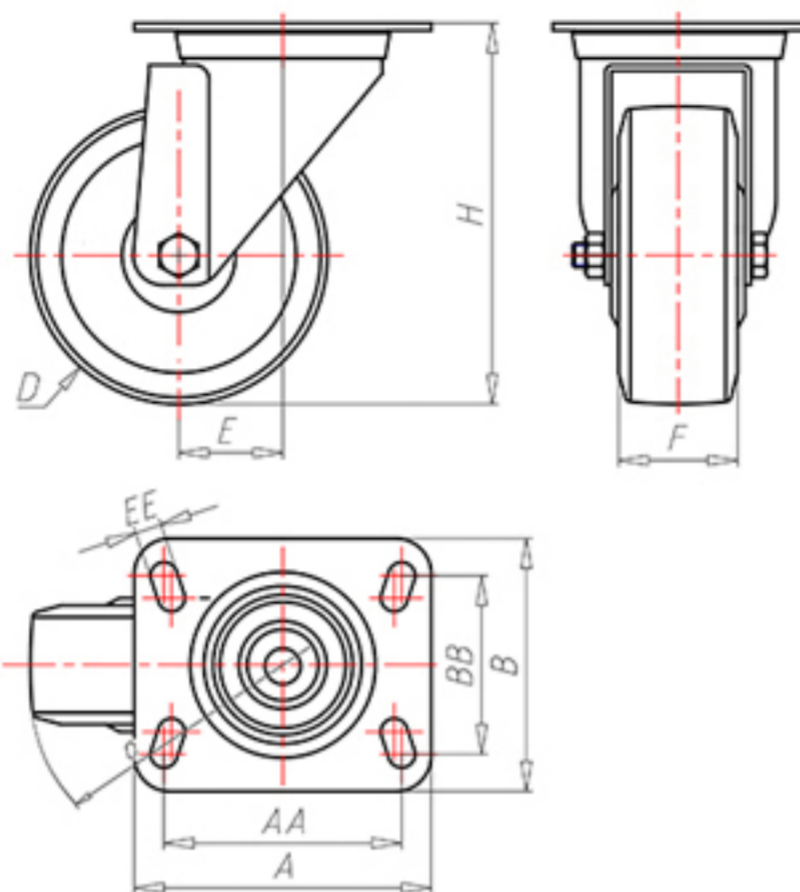

	D	125
	F	35
	H	155
	AxB	100x85
	AAxBB	80x60
	EE	9
	E	44
	O	107
	LC	230



Code for plain bore wheel

XNGZ12545



Code for wheel with roller bearing

XNGZ12545R



Code for wheel with double sealed ball bearing

XNGZ125C



Code for wheel with double sealed Inox ball bearing

-

