

D-NAMIC

92 Shore A
+90°C
-40°C

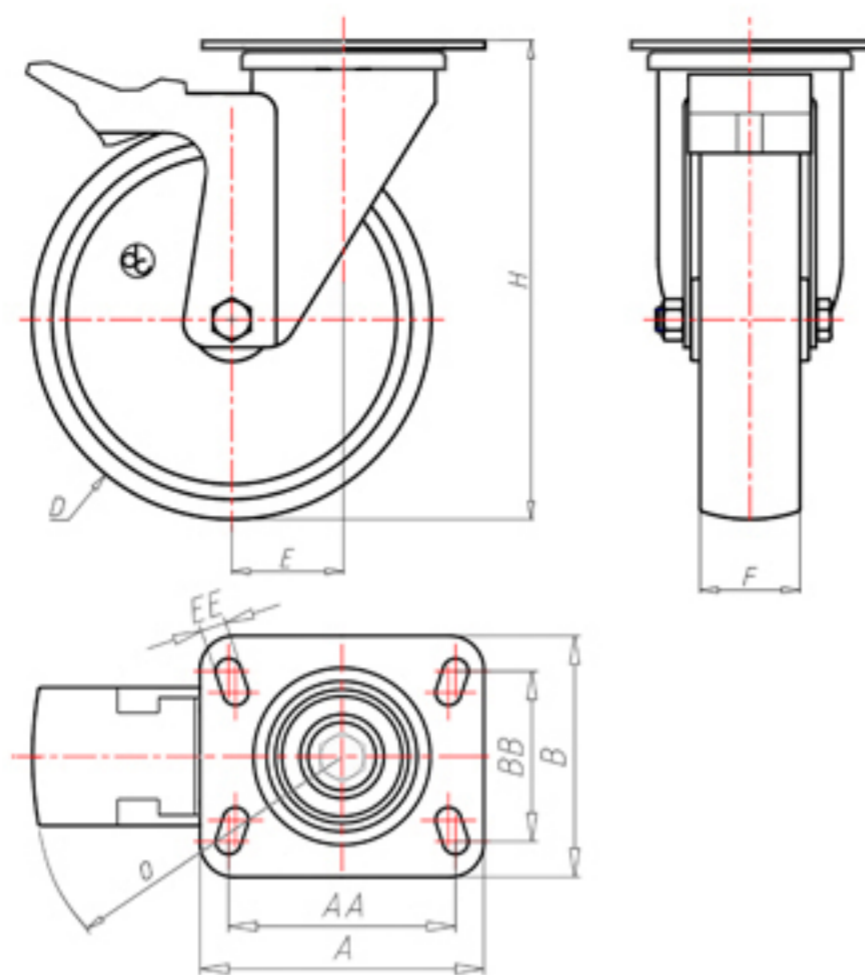

	D	150
	F	40
	H	184
	AxB	100x85
	AAxBB	80x60
	EE	9
	E	46
	O	124
	LC	280



Code for plain bore wheel

XNGZ15045PFA



Code for wheel with roller bearing

XNGZ15045PRFA



Code for wheel with double sealed ball bearing

XNGZ15045PCFA



Code for wheel with double sealed Inox ball bearing

-

