

D-NAMIC

92 Shore A  
+90°C  
-40°C

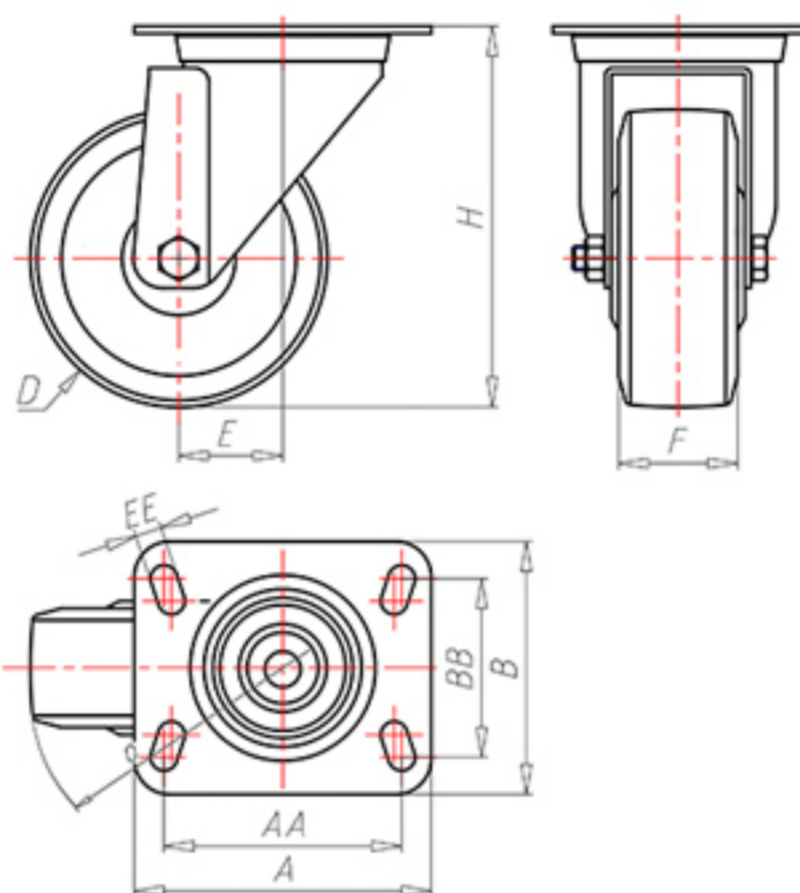

	D	80
	F	33
	H	108
	AxB	100x85
	AAxBB	80x60
	EE	9
	E	40
	O	82
	LC	200



Code for plain bore wheel

XNGZ8045



Code for wheel with roller bearing

XNGZ8045R



Code for wheel with double sealed ball bearing

XNGZ80C



Code for wheel with double sealed Inox ball bearing

-

