

D-NAMIC

92 Shore A  
+90°C  
-40°C

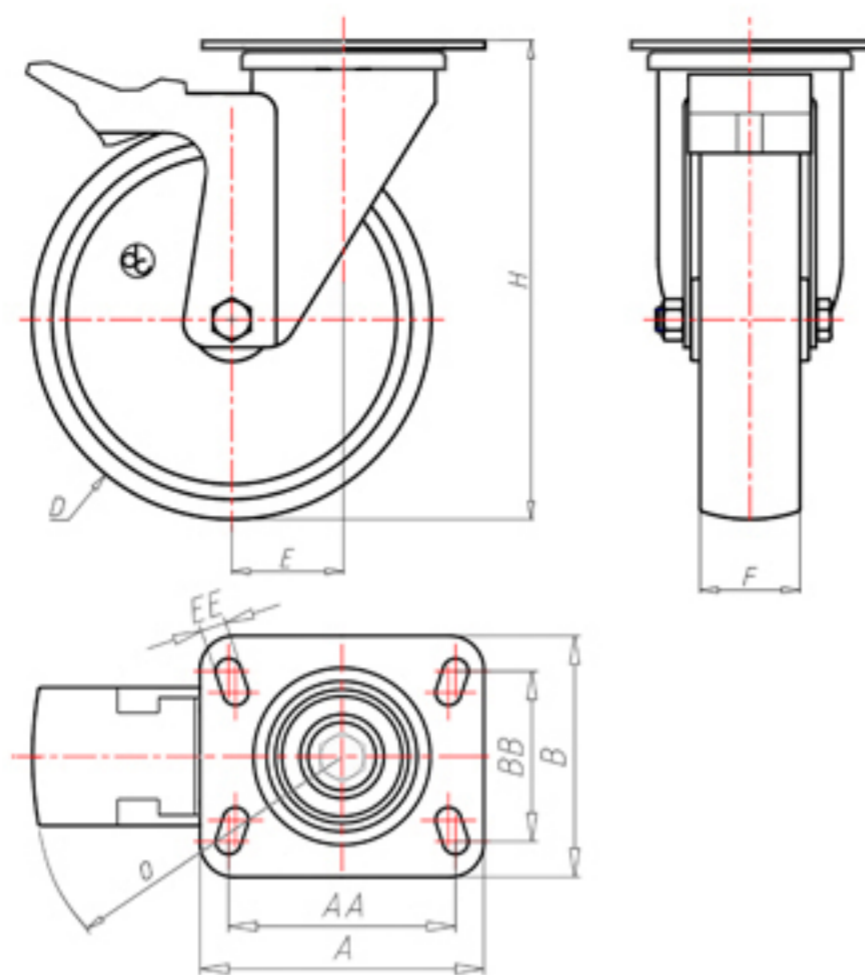

	D	80
	F	33
	H	110
	AxB	100x85
	AAxBB	80x60
	EE	9
	E	40
	O	124
	LC	210



Code for plain bore wheel

XNGZ8045PFA



Code for wheel with roller bearing

XNGZ8045PRFA



Code for wheel with double sealed ball bearing

XNGZ80PCFA



Code for wheel with double sealed Inox ball bearing

-

