

D-NAMIC

92 Shore A
+90°C
-40°C

INOX

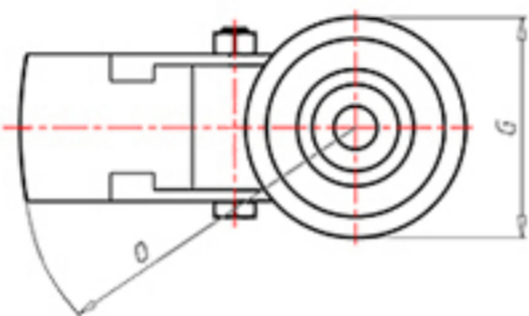
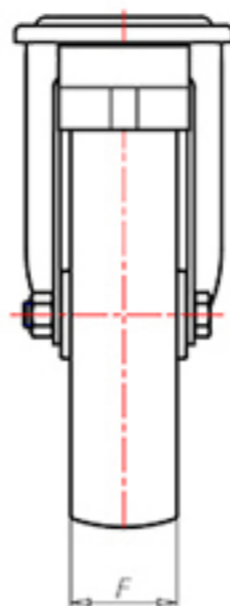
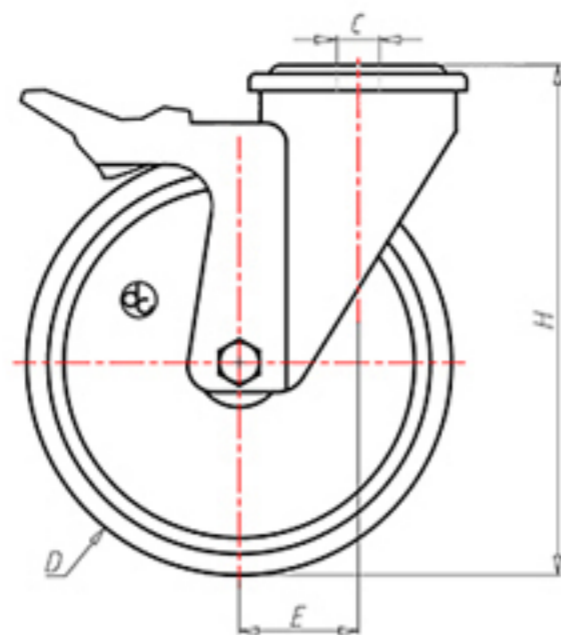

	D	100
	F	33
	H	128
	G	Ø 77
	C	Ø 12
	E	42
	O	124
	LC	220



Code for plain bore wheel

XNPX10040FA



Code for wheel with Inox roller bearing

XNPX10040RXFA



Code for wheel with double sealed ball bearing

XNPX10040CFA



Code for wheel with double sealed Inox ball bearing

XNPX10040CXFA

