

D-NAMIC

92 Shore A  
+90°C  
-40°C

INOX

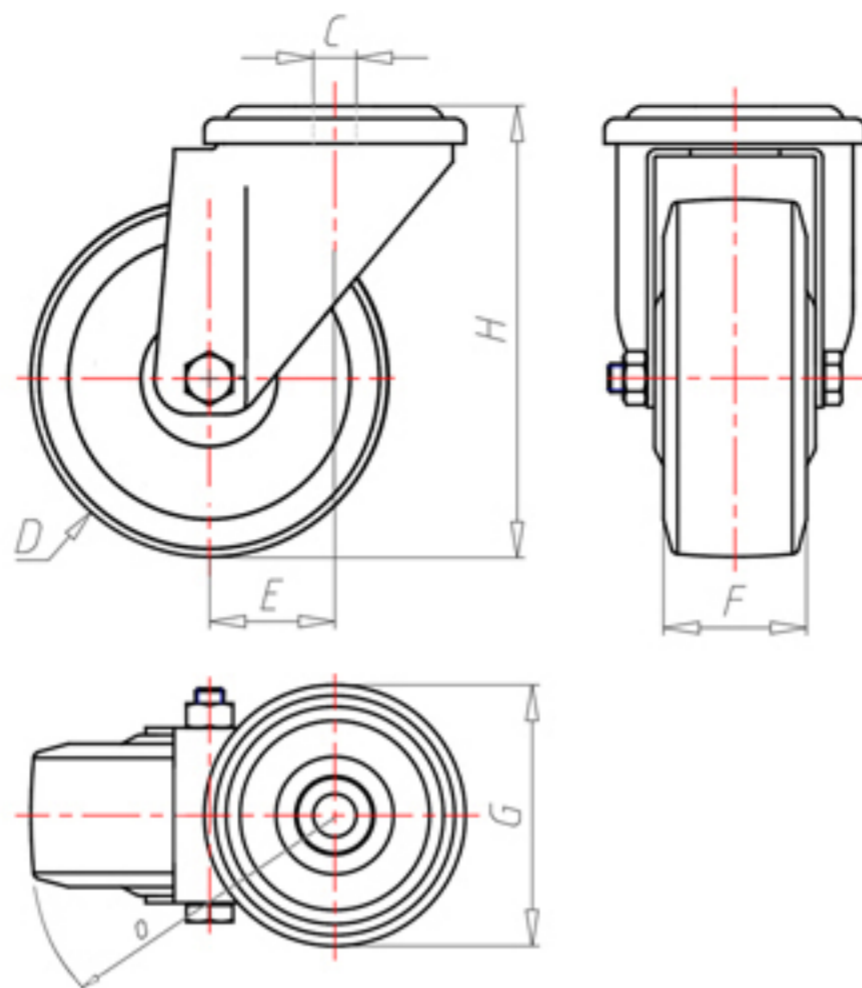

	D	100
	F	33
	H	128
	G	Ø 77
	C	Ø 12
	E	42
	O	92
	LC	220



Code for plain bore wheel

XNPX10045



Code for wheel with Inox roller bearing

XNPX10045RX



Code for wheel with double sealed ball bearing

XNPX100C



Code for wheel with double sealed Inox ball bearing

XNPX100CX

