

D-NAMIC

92 Shore A
+90°C
-40°C

INOX

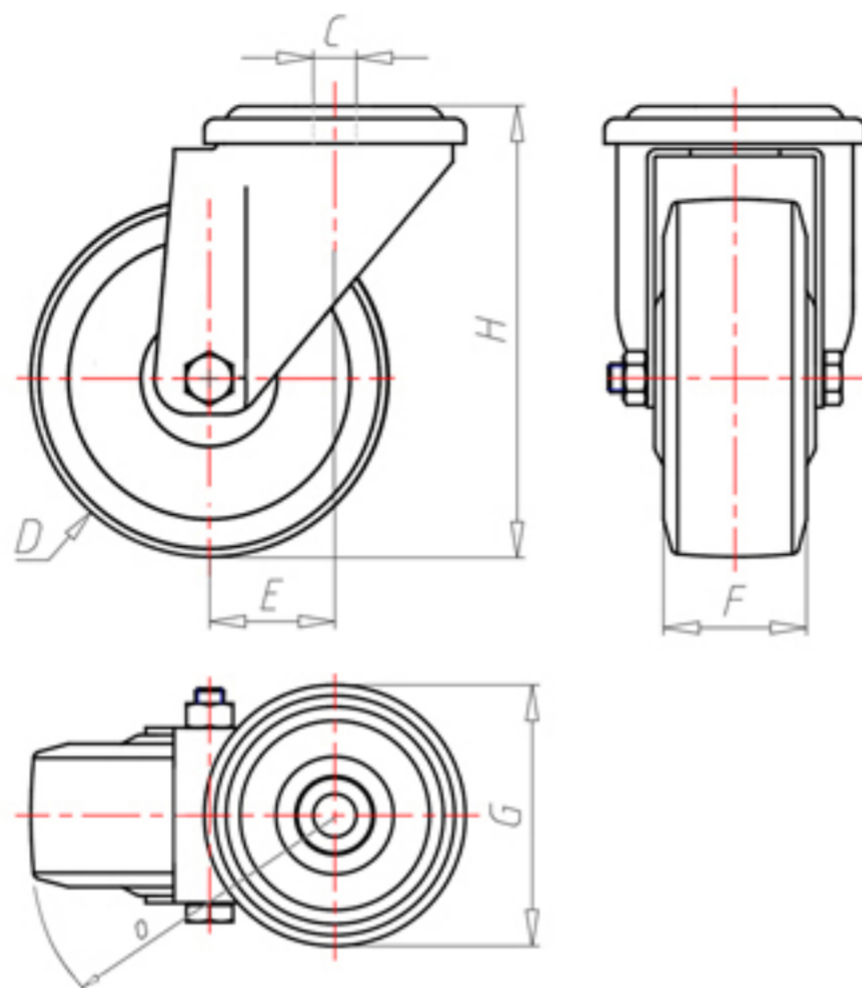

	D	200
	F	50
	H	232
	G	Ø 102
	C	Ø 16
	E	56
	O	152
	LC	400



Code for plain bore wheel

XNPX20060



Code for wheel with Inox roller bearing

XNPX20060RX



Code for wheel with double sealed ball bearing

XNPX200C



Code for wheel with double sealed Inox ball bearing

XNPX200CX

