

D-NAMIC

92 Shore A  
+90°C  
-40°C

INOX

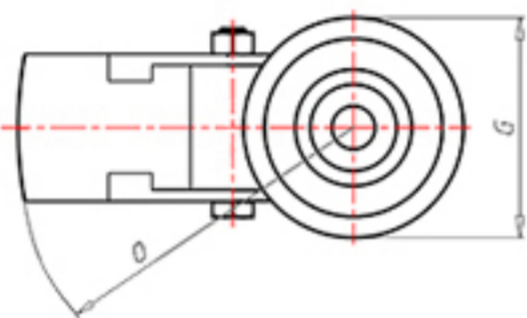
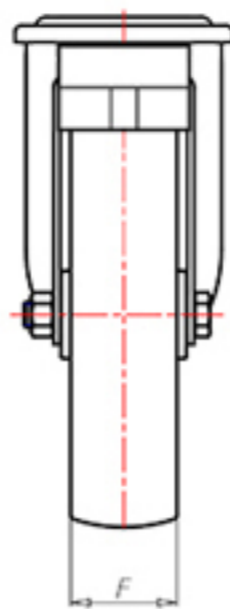
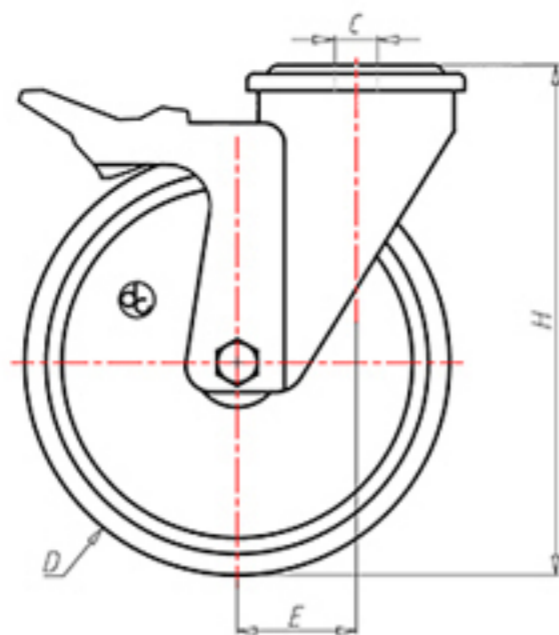

	D	80
	F	33
	H	108
	G	Ø 77
	C	Ø 12
	E	40
	O	124
	LC	200



Code for plain bore wheel

XNPX8045FA



Code for wheel with Inox roller bearing

XNPX8045RXFA



Code for wheel with double sealed ball bearing

XNPX80CFA



Code for wheel with double sealed Inox ball bearing

XNPX80CXFA

