

D-NAMIC

92 Shore A
+90°C
-40°C

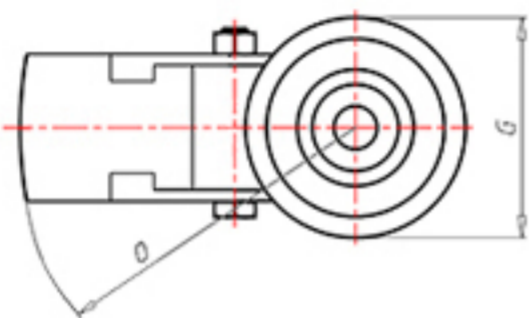

	D	100
	F	33
	H	128
	G	Ø 77
	C	Ø 12
	E	42
	O	124
	LC	220

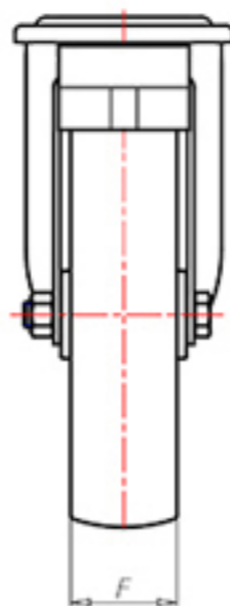
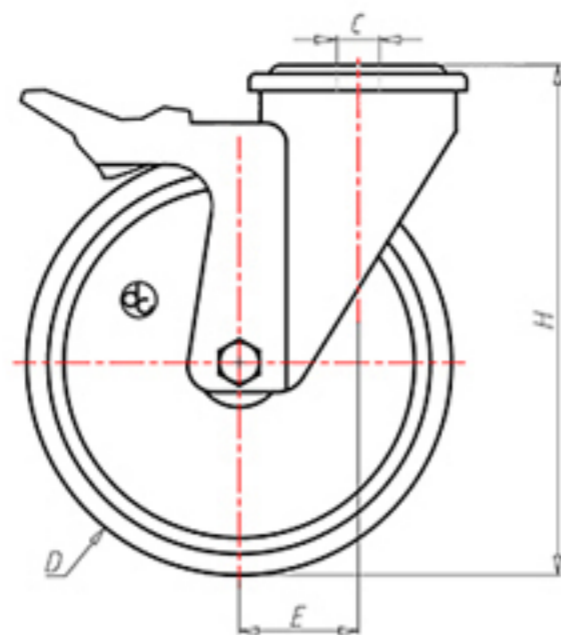

Code for plain bore wheel

XNPZ10045FA



Code for wheel with roller bearing

XNPZ10045RFA



Code for wheel with double sealed ball bearing

XNPZ100CFA



Code for wheel with double sealed Inox ball bearing

-

