

D-NAMIC

92 Shore A
+90°C
-40°C

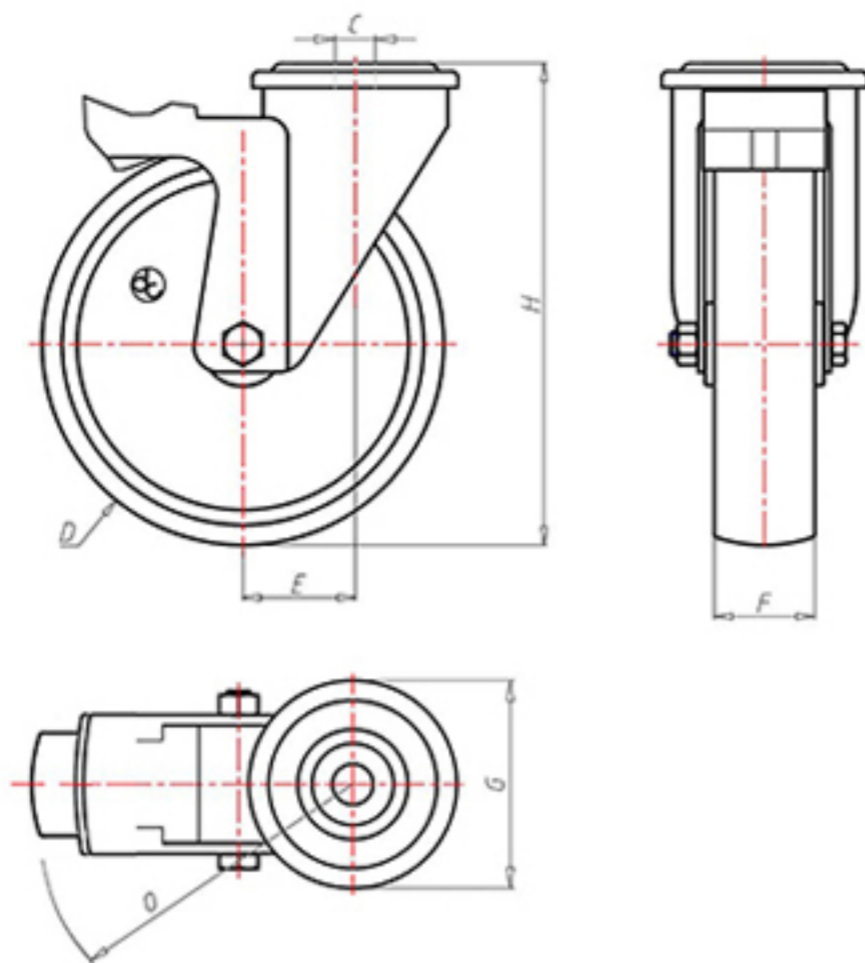

	D	100
	F	33
	H	128
	G	Ø 77
	C	Ø 12
	E	42
	O	124
	LC	220



Code for plain bore wheel

XNPZ10045FS



Code for wheel with roller bearing

XNPZ10045RFS



Code for wheel with double sealed ball bearing

XNPZ100CFS



Code for wheel with double sealed Inox ball bearing

-

